

# POPSTER

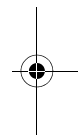
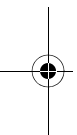
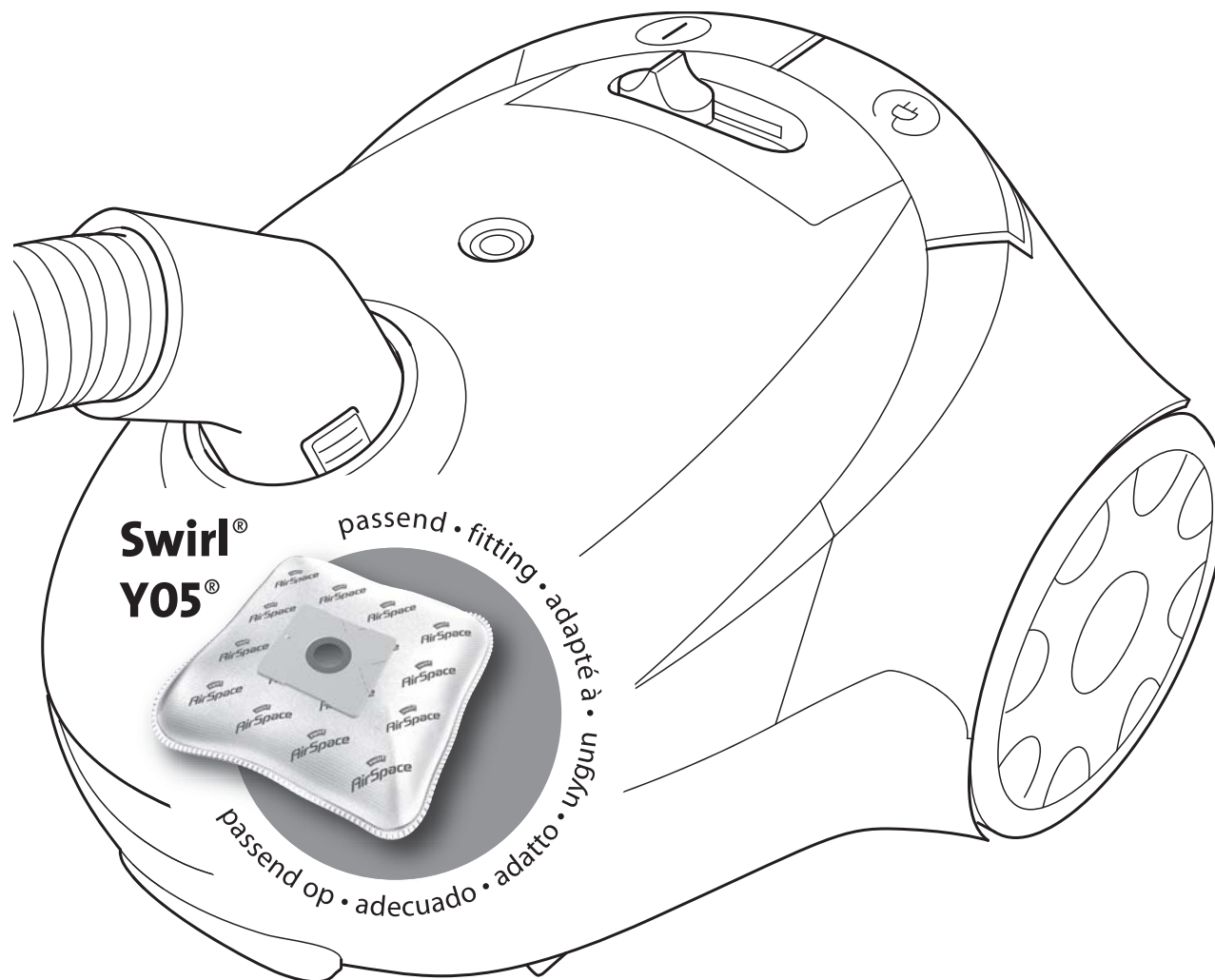

**DE** **Bedienungsanleitung**  
Beutel-Bodenstaubsauger

**GB** **Operating Manual**  
Cylinder vacuum cleaner  
with bag

**FR** **Mode d'emploi**  
Aspirateur-traîneau avec  
sac à poussière

**NL** **Bedieningshandleiding**  
Stofzuiger met zak

**ES** **Manual de instrucciones**  
Aspiradora rodante  
con bolsa

**IT** **Istruzioni per l'uso**  
Aspirapolvere a sacchetto

**TR** **Kullanım Klavuzu**  
Torbali elektrik süpürgesi

**Dirt Devil**  

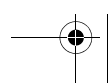
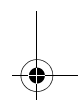
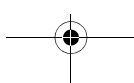
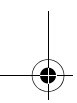

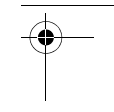
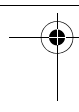
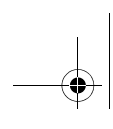
**Bedienungsanleitung ..... 4 - 8**

DE

**Operating Manual ..... 9 - 13**

GB

**Mode d'emploi ..... 14 - 18**

FR

**Bedieningshandleiding ..... 19 - 23**

NL

**Manual de instrucciones ..... 24 - 28**

ES

**Istruzioni per l'uso ..... 29 - 33**

IT

**Kullanım Klavuzu ..... 34 - 38**

TR

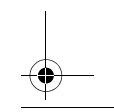
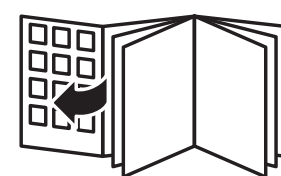
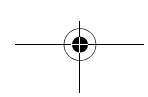
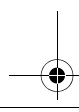
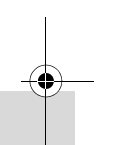
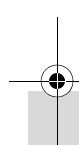

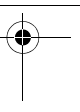
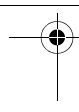

 **Royal**

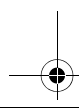
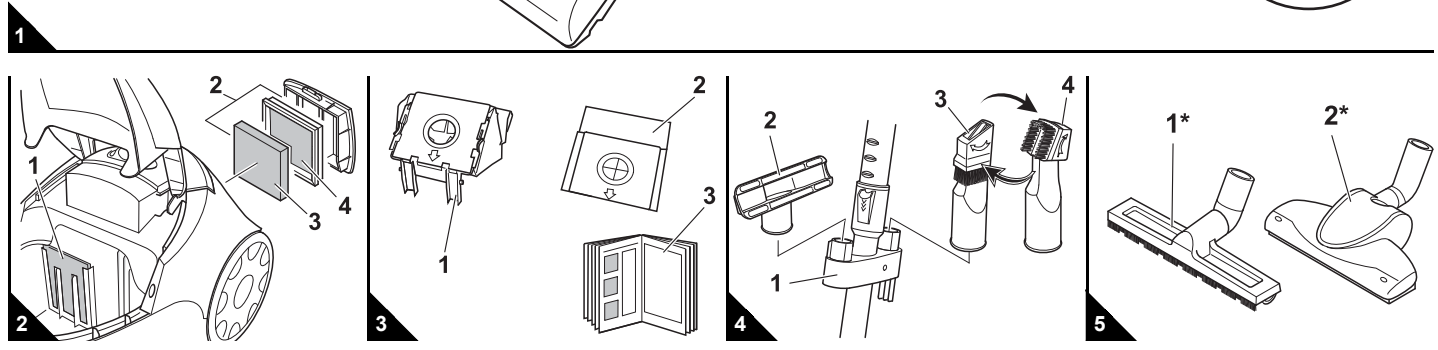
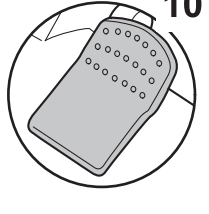
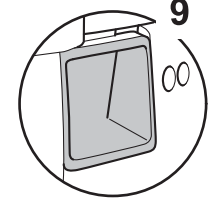
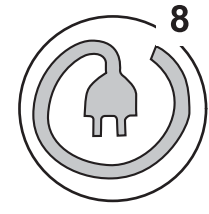
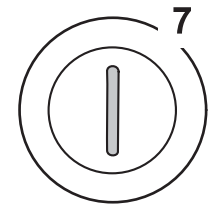
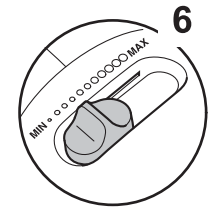
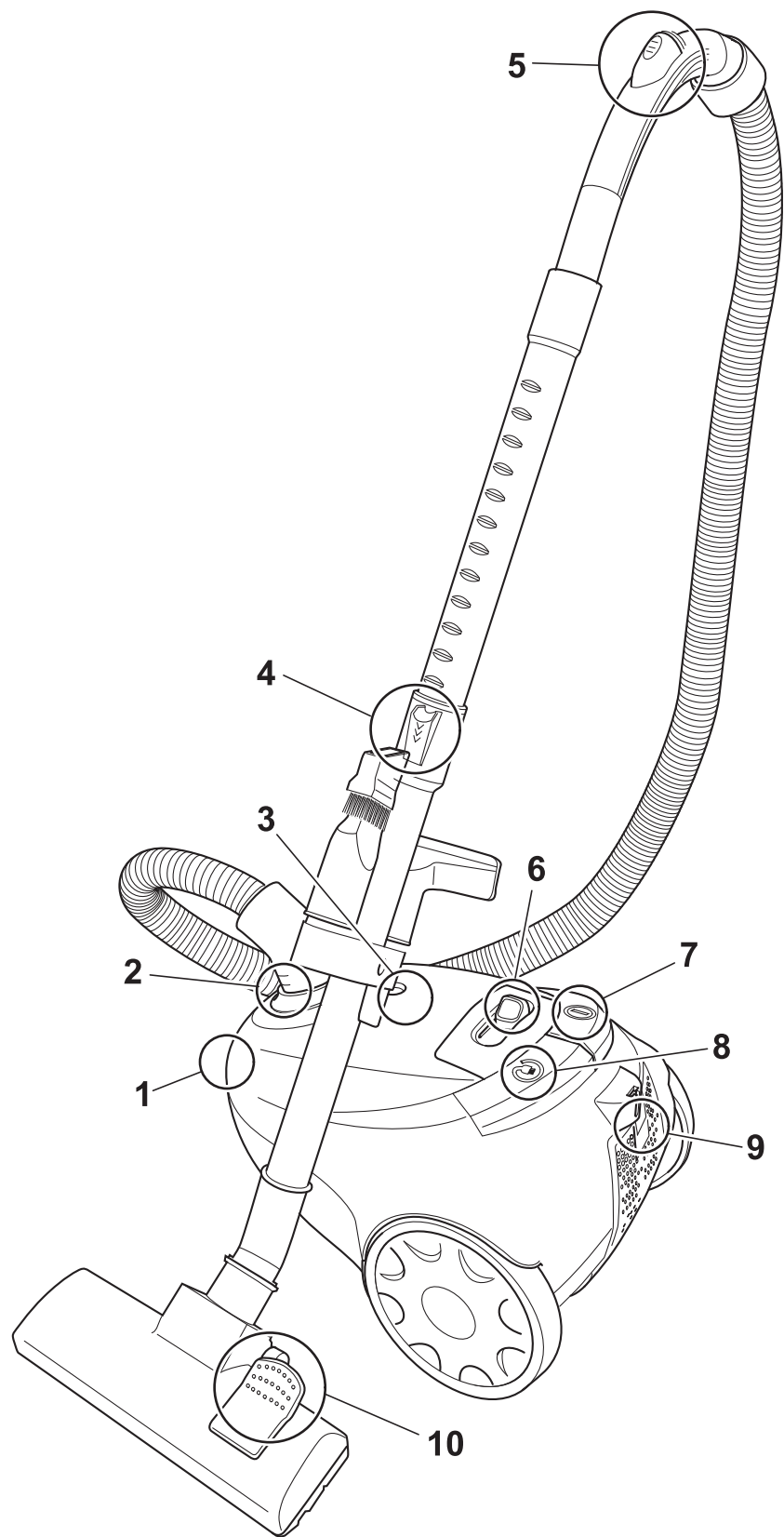
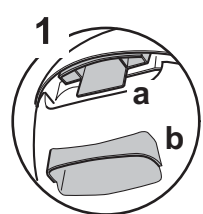
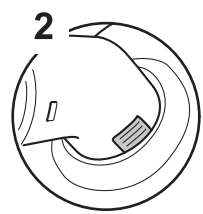
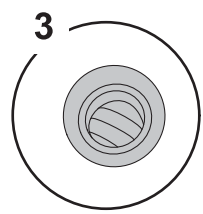
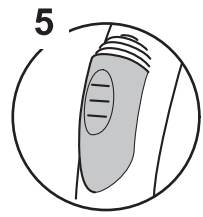

3

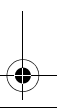
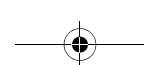

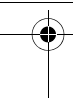

# 1 Überblick und Sicherheit

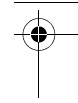

## Vielen Dank!

Wir danken Ihnen für den Kauf des POPSTER und das entgegengebrachte Vertrauen.

## Überblick

### Abb. 1:

- 1 a: Entriegelung für den Staubraumdeckel;  
b: Griffmulde zum Tragen
- 2 Entriegelungstasten für den Saugschlauch
- 3 Staubfilterbeutel-Wechselanzeige
- 4 Teleskoprohr-Arretierung
- 5 Nebenluftregler
- 6 Saugleistungsregler
- 7 Ein-/Aus-Schalter
- 8 Kabelaufrolltaste
- 9 Entriegelung der Ausblasfilter-Abdeckung
- 10 Umschalter „Teppich/Hartboden“

### Abb. 2:

- 1 Motorschutzfilter
- 2 Ausblasfiltereinheit bestehend aus:
- 3 Schaumstofffilterelement
- 4 Filterhalter mit eingenähtem Vlies

### Abb. 3:

- 1 Papier-Staubfilterbeutel mit Halterung (im Gerät)
- 2 ein weiterer Papier-Staubfilterbeutel (im Karton)
- 3 Bedienungsanleitung

### Abb. 4:

- 1 Zubehöralterung
- 2 Polsterdüse
- 3 2in1-Kombidüse als Fugendüse
- 4 2in1-Kombidüse als Möbelpinsel

### Abb. 5:

\* optionales Zubehör:

- 1 \*Parkettbürste (M203):  
zum Saugen von empfindlichen Oberflächen (z. B. Laminat, Parkett)
- 2 \*Turbobürste (M209):  
zur Tiefenreinigung von Teppichen per rotierendem Bürstkopf

## Technische Daten

Geräteart : Bodenstaubsauger  
 Modell : POPSTER  
           M7012 (-0/.../9)  
 Spannung : 220 – 240 V~,  
           50/60 Hz  
 Leistung : 1.400 W nom –  
           2.000 W max  
 Staubbeutel- : Max. nutzbares Füllvolumen  
           volumen 1,5 Liter  
 Stromkabel- : ca. 5 m  
           länge  
 Gewicht : ca. 4,5 kg



Technische und gestalterische Änderungen im Zuge stetiger Produktverbesserungen vorbehalten.  
© Royal Appliance International GmbH

## 1.1 zur Bedienungsanleitung

Lesen Sie diese Bedienungsanleitung vollständig durch, bevor Sie mit dem Gerät arbeiten. Bewahren Sie die Anleitung gut auf. Falls Sie das Gerät an Dritte weitergeben, geben Sie die Bedienungsanleitung mit.

Wichtige Hinweise für Ihre Sicherheit sind besonders gekennzeichnet. Beachten Sie diese Hinweise unbedingt, um Unfälle und Schäden am Gerät zu vermeiden:

### ⚠️ WARNUNG:

Warnt vor Gefahren für Ihre Gesundheit und zeigt mögliche Verletzungsrisiken auf.

### ⚠️ ACHTUNG:

Weist auf mögliche Gefährdungen für das Gerät oder andere Gegenstände hin.

### HINWEIS:

Hebt Tipps und Informationen für Sie hervor.

**Die Nichtbeachtung dieser Anleitung kann zu schweren Verletzungen oder Schäden am Gerät führen.**

Für Schäden, die durch Nichtbeachtung dieser Bedienungsanleitung entstehen, übernehmen wir keine Haftung.

## 1.2 zu Kindern

■ Dieses Gerät ist nicht dafür bestimmt, durch Personen (einschließlich Kinder) mit eingeschränkten physischen, sensorischen oder geistigen Fähigkeiten oder mangels Erfahrung und/oder mangels Wissen benutzt zu werden, es sei denn, sie werden durch eine für ihre Sicherheit zuständige Person beaufsichtigt oder erhielten von ihr Anweisungen, wie das Gerät zu benutzen ist. Kinder sollten beaufsichtigt werden, um sicherzustellen, dass sie nicht mit dem Gerät spielen. Bewahren Sie das Gerät für diesen Personenkreis unzugänglich auf.

■ Verpackungsmaterialien dürfen nicht zum Spielen verwendet werden. Es besteht Erstickungsgefahr.

## 1.3 zur bestimmungsgemäßen Verwendung

■ Der Bodenstaubsauger darf nur im Haushalt eingesetzt werden. Er ist für eine gewerbliche Nutzung nicht geeignet.

■ Verwenden Sie den Bodenstaubsauger ausschließlich für das Reinigen von trockenen, normal verschmutzten Böden, Teppichen und Gardinen.

**Jede weitere Verwendung gilt als nicht bestimmungsgemäß und ist untersagt.**

**Verboten ist insbesondere:**

- Das Saugen von:
  - Körperteilen und Tieren. Sie könnten eingezogen und verletzt werden.
  - am Körper befindlichen Kleidungsstücken. Sie könnten eingezogen werden und Verletzungen hervorrufen.
  - Wasser und anderen Flüssigkeiten, insbesondere feuchten Teppich-Reinigungsmitteln. Feuchtigkeit im Inneren kann zum Kurzschluss führen.
  - Tonerstaub (für Laserdrucker, Kopierer usw.). Es besteht Brand- und Explosionsgefahr.
  - glühender Asche, brennenden Zigaretten oder Streichhölzern. Es kann zum Brand kommen.
  - spitzen Gegenständen, wie Glassplittern, Nägeln usw. Das Gerät könnte beschädigt werden.
  - Bauschutt, Gips, Zement, feinstem Bohrstaub, Schminke usw. Das Gerät könnte beschädigt werden.
- Die Verwendung in der Nähe von explosiven oder leicht entzündlichen Stoffen. Es besteht Brand- oder Explosionsgefahr.
- Die Verwendung im Freien. Es besteht die Gefahr, dass Regen und Schmutz das Gerät zerstören.
- Das Hineinstecken von Gegenständen in die Öffnungen des Gerätes. Es besteht Verletzungsgefahr.
- Das selbstständige Umbauen oder Reparieren des Gerätes. Es besteht Verletzungsgefahr.

## 1.4 zur Stromversorgung

■ Das Gerät wird mit elektrischem Strom betrieben, dabei besteht grundsätzlich die Gefahr eines elektrischen Schlags. Achten Sie daher besonders auf Folgendes:

- Fassen Sie den Stecker nie mit nassen Händen an.
- Wenn Sie den Stecker aus der Steckdose herausziehen wollen, ziehen Sie immer direkt am Stecker. Ziehen Sie niemals am Stromkabel, es könnte reißen.
- Achten Sie darauf, dass das Stromkabel nicht geknickt, eingeklemmt, überfahren wird oder mit Hitzequellen in Berührung kommt.
- Verwenden Sie nur Verlängerungskabel, die für die Leistungsaufnahme des Gerätes ausgelegt sind.
- Tauchen Sie das Gerät niemals in Wasser oder andere Flüssigkeiten und halten Sie es von Regen und Nässe fern.
- Betreiben Sie das Gerät nur, wenn die auf dem Typenschild angegebene elektrische Spannung mit der Spannung Ihrer Steckdose übereinstimmt. Falsche Spannung kann das Gerät beschädigen.

## 1.5 bei defektem Gerät

■ Betreiben Sie niemals ein defektes Gerät oder ein Gerät mit einem defekten Stromkabel. Wenn die Anschlussleitung dieses Gerätes beschädigt wird, muss sie durch den Hersteller oder seinen Kundendienst oder eine ähnlich qualifizierte Person ersetzt werden, um Gefährdungen zu vermeiden.

■ Geben Sie ein defektes Gerät zur Reparatur an einen Fachhändler oder den Royal Appliance-Kundendienst. Adresse > Kapitel 4.4, „Im Garantiefall“.

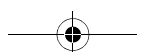



## 2 Bedienung

**Royal**

### 2.1 Auspacken und Montieren

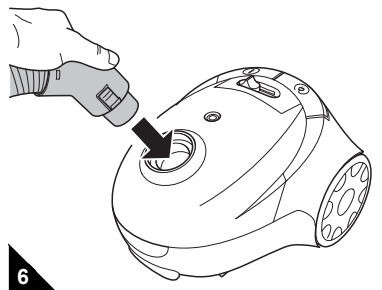

6

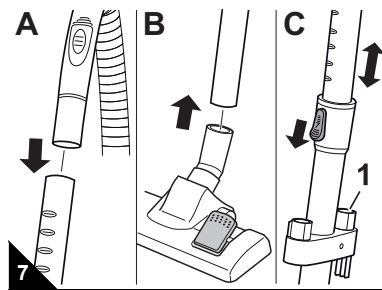

7

1. Packen Sie das Gerät samt Zubehör aus.
2. Überprüfen Sie den Inhalt auf Unversehrtheit und Vollständigkeit (Abb. 1–5).

**HINWEIS:**

Sollten Sie einen Transportschaden bemerken, wenden Sie sich umgehend an Ihren Händler.

**ACHTUNG:**

Transportieren/versenden Sie das Gerät grundsätzlich in der Originalverpackung, damit es keinen Schaden nimmt. Heben Sie dazu die Originalverpackung auf. Entsorgen Sie dagegen nicht mehr benötigtes Verpackungsmaterial ordnungsgemäß.

**WARUNG:**

Verletzungsgefahr! Montieren Sie das Gerät nur, wenn der Stecker aus der Steckdose gezogen ist. Andernfalls kann das Gerät anlaufen und Körperteile, Haare oder Kleidungsstücke können eingezogen werden.

3. Stecken Sie das Ende des Saugschlauchs wie abgebildet in die Aufnahmeöffnung, bis die Verriegelung hör- und spürbar einrastet (Abb. 6).
4. Stecken Sie den Handgriff in das obere Ende des Teleskoprohrs (Abb. 7/A).
5. Stecken Sie die gewünschte Düse auf das Teleskoprohr (Abb. 7/B).
6. Stellen Sie die Länge des Teleskoprohrs ein. Drücken Sie dazu die Teleskoprohr-Arretierung nach unten (Abb. 7/C). Ziehen Sie dann das Teleskoprohr auf die gewünschte Länge. Zum Verriegeln lassen Sie die Teleskoprohr-Arretierung beim Ziehen los. Sie hören ein deutliches Klicken.
7. Bringen Sie eventuell nicht benötigtes Zubehör wie abgebildet in der Zubehöralterung (Abb. 7/C1) unter. Ihr Bodenstaubsauger ist jetzt einsatzbereit.

### 2.2 Staubsaugen

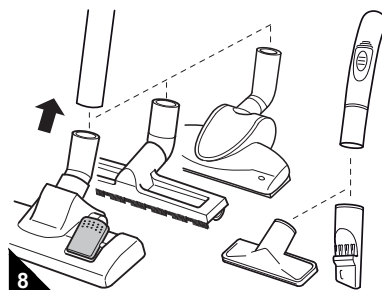

8

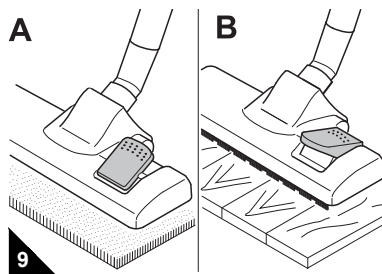

9

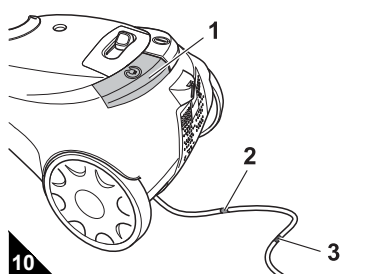

10

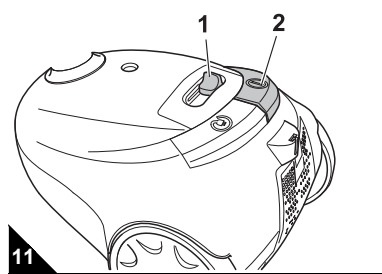

11

**WARUNG:**

Verletzungsgefahr! Ein beschädigtes Gerät darf nicht verwendet werden. Prüfen Sie den Bodenstaubsauger und das Stromkabel vor jeder Benutzung.

**WARUNG:**

Verletzungsgefahr! Achten Sie insbesondere beim Saugen von Treppen darauf, dass Sie sich stets oberhalb des Geräts befinden.

**ACHTUNG:**

Verwenden Sie den Bodenstaubsauger nur, wenn alle Filter intakt, trocken und korrekt eingesetzt sind. Stellen Sie sicher, dass keine Öffnungen verstopft sind. Andernfalls kann der Staubsauger beschädigt werden.

**HINWEIS:**

Ihr Bodenstaubsauger besitzt einen Überhitzungsschutz. Er schaltet sich bei Überhitzung automatisch ab. Ist dies der Fall, schalten Sie den Bodenstaubsauger aus und ziehen Sie den Stecker. Beseitigen Sie die Ursache der Überhitzung. Warten Sie ca. 45 Minuten. Den abgekühlten Bodenstaubsauger können Sie wieder einschalten.

1. Stecken Sie die gewünschte Düse auf (Abb. 8).

**ACHTUNG:**

Beachten Sie die Empfehlungen der Belaghersteller und ob die betreffende Düse für den jeweiligen Belag geeignet ist.

2. Stellen Sie bei Verwendung der Bodendüse den Umschalter „Teppich/Hartboden“ je nach Bodenbelag ein:
  - **Teppich (Abb. 9/A)**: für lang-/kurzflorige Teppiche, Läufer usw.
  - **Hartboden (Abb. 9/B)**: für Laminat, Fliesen, PVC usw.
3. Ziehen Sie das Stromkabel bis zur gelben Markierung (Abb. 10/3) heraus.

**WARUNG:**

Gefahr eines elektrischen Schlags! Falls die rote Markierung (Abb. 10/2) sichtbar ist, ziehen Sie das Kabel mithilfe der Kabelaufrolltaste (Abb. 10/1) wieder bis zur gelben Markierung (Abb. 10/3) ein. Andernfalls kann das Kabel beschädigt werden.

4. Stecken Sie den Stecker in eine Steckdose mit Schutzkontakt.
5. Schalten Sie den Bodenstaubsauger am Ein-/Aus-Schalter (Abb. 11/2) ein.
6. Stellen Sie den Saugleistungsregler (Abb. 11/1) je nach zu saugendem Untergrund ein.
7. Ziehen Sie den Bodenstaubsauger zum Saugen wie einen Schlitten hinter sich her.

**HINWEIS:**

Mit dem Nebenluftregler (Abb. 1/5) können Sie die Saugleistung schnell reduzieren, wenn weniger Saugleistung benötigt wird, z. B. um eingesaugte Gegenstände wieder freizugeben.

DE



5



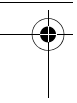

## 2 Bedienung

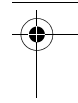
**Royal**

### 2.3 Ausschalten

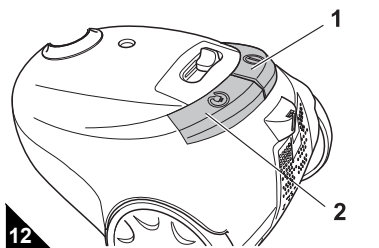

1. Schalten Sie den Bodenstaubsauger am Ein-/Aus-Schalter (Abb. 12/1) aus und ziehen Sie den Stecker aus der Steckdose.
2. Behalten Sie den Stecker in der Hand.

**⚠️ WARNUNG:**

Verletzungsgefahr! Beim unkontrollierten Einziehen des Stromkabels kann dieses umherschlingern, zur Stolperfalle werden oder Gegenstände umreißen. Behalten Sie daher den Stecker in der Hand und führen Sie ihn beim Einziehen des Stromkabels mit.

3. Drücken Sie die Kabelauffrolltaste (Abb. 12/2), um das Stromkabel einzuziehen.

### 2.4 Transportieren und Verstauen

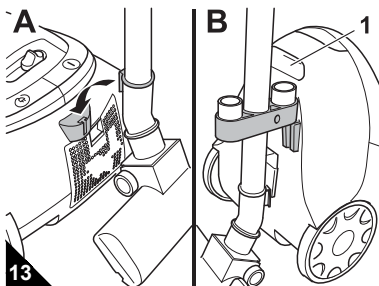

- Zum **Transport** können Sie das Gerät am Tragegriff (Abb. 13/B1) tragen.
- Bei **Arbeitspausen** können Sie den Parkhaken in die Parkhalterung einhängen (Abb. 13/A).
- Zum **Verstauen** können Sie den Verstauhaken in die Verstauhalterung einhängen (Abb. 13/B).
- Es empfiehlt sich, vorher das Teleskoprohr einzufahren ▷ *Kapitel 2.1, „Auspacken und Montieren“*, Schritt 4.

**⚠️ ACHTUNG:**

Stellen Sie das Gerät nie direkt neben Wärmequellen ab (z. B. Heizung, Ofen). Vermeiden Sie direkte Sonneneinstrahlung. Die Hitze kann das Gerät beschädigen.

- Zum **Verstauen** über einen längeren Zeitraum entnehmen Sie den Staubfilterbeutel ▷ *Kapitel 2.5, „Staubfilterbeutel wechseln“* und entsorgen Sie ihn ordnungsgemäß. Lagern Sie das Gerät dann stets kühl, trocken und für Kinder unzugänglich.

### 2.5 Staubfilterbeutel wechseln

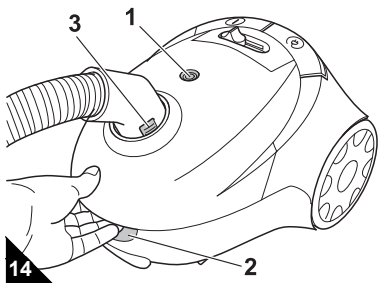
**⚠️ ACHTUNG:**

Bevor Sie den Staubfilterbeutel wechseln, schalten Sie das Gerät aus. So vermeiden Sie, dass Staub das Gerät beschädigt.

- Wechseln Sie den Staubfilterbeutel, wenn die Staubfilterbeutel-Wechselanzeige (Abb. 14/1) „rot“ anzeigt, vor längerer Lagerung oder vor Weiterversand.
- Wechseln Sie den Staubfilterbeutel aus hygienischen Gründen zudem spätestens alle 3 Monate.

1. Schalten Sie das Gerät aus und ziehen Sie den Stecker aus der Steckdose, ▷ *Kapitel 2.3, „Ausschalten“*.
2. Öffnen Sie den Staubraumdeckel, indem Sie seine Entriegelungstaste drücken (Abb. 14/2) und ihn anschließend aufklappen.
3. Klappen Sie den Staubraumdeckel so weit auf, bis er spürbar einrastet und von selbst geöffnet bleibt.

**HINWEIS:**

Sollte der Staubraumdeckel nicht von allein geöffnet bleiben, empfiehlt es sich, vorher den Saugschlauch zu entnehmen. Drücken Sie hierfür beide Entriegelungstasten (Abb. 14/3) und ziehen Sie den Saugschlauch aus seiner Aufnahme.

4. Ziehen Sie den Staubbeutelhalter samt Staubfilterbeutel wie abgebildet (Abb. 15) nach oben heraus.

**HINWEIS:**

Gehen Sie beim Entnehmen des Staubfilterbeutels vorsichtig vor, damit kein Staub aus dem Staubfilterbeutel austreten kann.

5. Ziehen Sie den vollen Staubfilterbeutel nach oben aus dem Staubbeutelhalter heraus (Abb. 16).

**HINWEIS:**

Den Inhalt des Staubfilterbeutels können Sie im Hausmüll entsorgen, solange er keinen für den Hausmüll verbotenen Schmutz enthält.

6. Schieben Sie den neuen Staubfilterbeutel wie abgebildet in den Staubbeutelhalter, bis er hinter den beiden Nasen und exakt an der Kante des Staubbeutelhalters anliegt (Abb. 16, Pfeile).
7. Entfernen Sie Staubrückstände, die sich eventuell im Staubraum befinden.
8. Kontrollieren Sie bei dieser Gelegenheit sogleich den Motorschutzfilter. Wechseln Sie ihn bei Bedarf, ▷ *Kapitel 3.3, „Motorschutzfilter reinigen“*.
9. Setzen Sie den Staubbeutelhalter samt neuem Staubfilterbeutel wieder ein:
  - Setzen Sie dafür den Staubbeutelhalter in die beiden dafür vorgesehenen Schienen ein (Abb. 17/Pfeile).
  - Drücken Sie den Staubbeutelhalter dann so weit nach unten, bis dieser sicher auf seiner Führung aufliegt.

**HINWEIS:**

Der Staubraumdeckel lässt sich nur schließen, wenn der Staubfilterbeutel korrekt eingesetzt ist.

10. Schließen Sie den Staubraumdeckel. Er rastet hörbar ein.

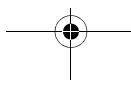
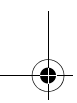
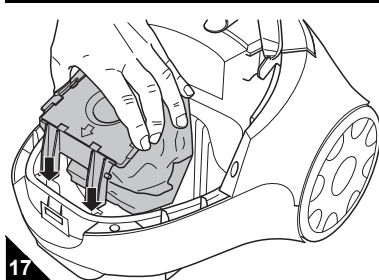
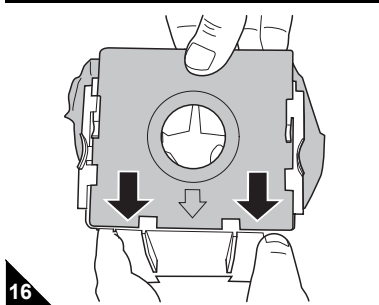
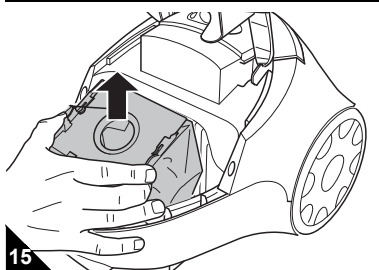



## 3 Wartung



### 3.1 Übersicht über die Filter

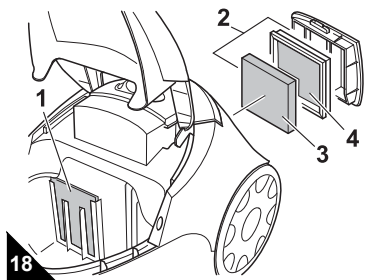

Die Filter können nach einiger Zeit verschmutzen und müssen daher regelmäßig kontrolliert werden:

**Folgende Filter sind installiert:**

■ **Motorschutzfilter (Abb. 18/1)**

Er verhindert bei defektem Staubfilterbeutel, dass größere Partikel den Motor beschädigen.

- *Austauschen: nach jedem 5. Staubfilterbeutel-Wechsel, spätestens alle 6 Monate (▷ Kapitel 3.3, „Motorschutzfilter reinigen“).*

■ **Ausblasfiltereinheit (Abb. 18/2) bestehend aus**

- **Schaumstofffilterelement (Abb. 18/3) und**
- **Filterhalter mit eingenähtem Vlies (Abb. 18/4)**

Die Ausblasfiltereinheit filtert feinste Partikel aus der ausgeblasenen Luft.

- *Austauschen: alle 6 Monate (▷ Kapitel 3.2, „Ausblasfiltereinheit reinigen“).*

DE

### 3.2 Ausblasfiltereinheit reinigen

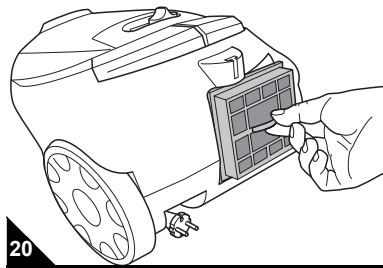
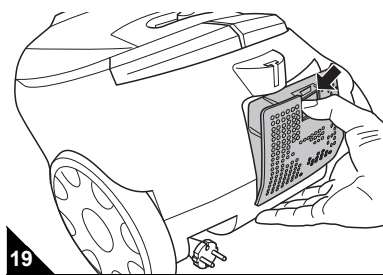

1. Schalten Sie das Gerät aus und ziehen Sie den Stecker aus der Steckdose, ▷ Kapitel 2.3, „Ausschalten“.
2. Drücken Sie die Entriegelung der Ausblasfilter-Abdeckung und klappen Sie die Abdeckung ab (Abb. 19).
3. Nehmen Sie die Ausblasfilter-Einheit an der dafür vorgesehenen Zunge aus ihrer Konsole (Abb. 20).
4. Halten Sie die Ausblasfiltereinheit tief über einen Mülleimer.
5. Nehmen Sie das Schaumstofffilterelement aus dem Filterhalter.
6. Spülen Sie beide Filterelemente von Hand mit klarem, kaltem Wasser gründlich aus.

**⚠ ACHTUNG:**

Die Filterelemente der Ausblasfiltereinheit sind waschbar, jedoch weder spülmaschinen- noch waschmaschinentauglich. Verwenden Sie außerdem zur Reinigung keine Reinigungsmittel. Lassen Sie die Filterelemente anschließend trocknen (ca. 24 Stunden bei Raumtemperatur). Setzen Sie sie erst wieder ein, wenn sie vollkommen trocken sind.

7. Falls eines der Filterelemente beschädigt oder verformt sein sollte, ersetzen Sie es durch ein neues (▷ Kapitel 3.4, „Zubehör- und Ersatzteilliste“).
8. Setzen Sie das gereinigte/neue Schaumstofffilterelement zurück in den Filterhalter.
9. Setzen Sie den frisch bestückten Filterhalter nun zurück in seine Konsole (Abb. 20). Die Entnahmezunge des Filterhalters muss dabei aus dem Gerät heraus zeigen.
10. Haken Sie die Ausblasfilter-Abdeckung zuerst unten ein und drücken Sie sie oben an, bis sie spürbar einrastet (Abb. 19).

### 3.3 Motorschutzfilter reinigen

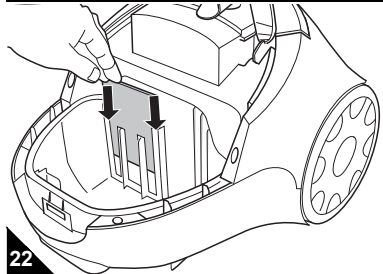
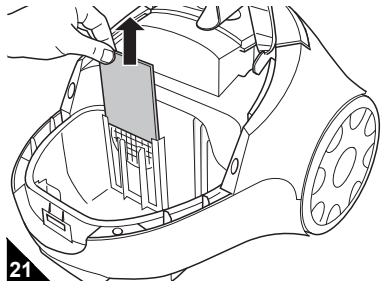

1. Schalten Sie das Gerät aus und entnehmen Sie den Staubbeutelhalter samt Staubfilterbeutel, ▷ Kapitel 2.5, „Staubfilterbeutel wechseln“, Schritte 1–4.
2. Ziehen Sie den Motorschutzfilter nach oben aus seiner Führung (Abb. 21).
3. Spülen Sie den Motorschutzfilter von Hand mit klarem, kaltem Wasser gründlich aus.

**⚠ ACHTUNG:**

Der Motorschutzfilter ist waschbar, jedoch weder spülmaschinen- noch waschmaschinentauglich. Verwenden Sie außerdem zur Reinigung keine Reinigungsmittel. Lassen Sie den Motorschutzfilter anschließend trocknen (ca. 24 Stunden bei Raumtemperatur). Setzen Sie ihn erst wieder ein, wenn dieser vollkommen trocken ist.

4. Falls der Motorschutzfilter beschädigt oder verformt sein sollte, ersetzen Sie ihn durch einen neuen (▷ Kapitel 3.4, „Zubehör- und Ersatzteilliste“).
5. Schieben Sie den Motorschutzfilter wieder in die dafür vorgesehenen Führungen (Abb. 22/Pfeile).
6. Setzen Sie den Staubbeutelhalter mit Staubfilterbeutel ein und schließen Sie den Staubraumdeckel. Er rastet hörbar ein.

### 3.4 Zubehör- und Ersatzteilliste

| Artikel-Nr. | Beschreibung   |
|-------------|--|
| 7010022     | Set mit 5 Staubfilterbeuteln und 1 Motorschutzfilter   |
| 7011002     | 1 Ausblasfiltereinheit (incl. Schaumstofffilterelement (Abb. 18/3) und Filterhalter (Abb. 18/4)) |
| M203        | 1 Parkettbürste  |
| M209        | 1 Turbobürste  |

### 3.5 Bezugsquellen

■ Bestellkontakt ▷ Rückseite der Anleitung.

■ Weitere Informationen finden Sie unter <http://www.dirtdevil.de>

### 3.6 Kaufempfehlung



Wir empfehlen zum Nachkauf: *Swirl® Y05 Staubfilterbeutel mit MicroPor® Filtration*

**HINWEIS:**

Beutel in Richtung "C" einlegen.

Swirl®, MicroPor® und "Y05" sind reg. Marken eines Unternehmens der Melitta Gruppe, die mit deren Genehmigung benutzt werden.





## 4 Problembehebung



### 4.1 Bevor Sie das Gerät einsenden

Bevor Sie Ihren zuständigen Royal-Vertragshändler, Royal-Servicepartner oder Ihren Fachmarkt kontaktieren, überprüfen Sie anhand der folgenden Tabelle, ob Sie das Problem selbst beseitigen können.

#### **WARNUNG:**

Verletzungsgefahr! Verwenden Sie niemals ein defektes Gerät! Bevor Sie auf Problemsuche gehen, schalten Sie das Gerät aus und ziehen Sie den Stecker,  $\triangleright$  *Kapitel 2.3, „Ausschalten“*.

| Problem   | mögliche Ursache  | Lösung  |
|---|---|---|
| Gerät lässt sich nicht einschalten.                                   | Stecker ist nicht eingesteckt.  | Stecken Sie den Stecker in eine Steckdose und schalten Sie das Gerät ein, $\triangleright$ <i>Kapitel 2.2, „Staubsaugen“</i> .  |
|   | Steckdose führt keinen Strom.   | Testen Sie den Bodenstaubsauger an einer anderen Steckdose, bei der Sie sicher sind, dass diese Strom führt.  |
|   | Stromkabel ist beschädigt.  | Lassen Sie das Stromkabel durch den Royal Appliance-Kundendienst ersetzen, Adresse $\triangleright$ letzte Seite.   |
| Gerät hört plötzlich auf zu saugen.                                   | Überhitzungsschutz hat angesprochen (möglicherweise aufgrund verstopfter Saugwege o. Ä.). | Schalten Sie das Gerät aus und ziehen Sie den Stecker aus der Steckdose. Beseitigen Sie die Ursache der Überhitzung (z. B. verstopfte Saugwege o. Ä.). Warten Sie ca. 45 Minuten. Das abgekühlte Gerät können Sie wieder einschalten. |
| Staubfilterbeutel-Wechselanzeige steht auf „Rot“                      | Staubfilterbeutel ist überfüllt.  | Wechseln Sie den Staubfilterbeutel $\triangleright$ <i>Kapitel 2.5, „Staubfilterbeutel wechseln“</i> .  |
|   | Düse, Teleskoprohr oder Saugschlauch sind verstopft.                                      | Entfernen Sie die Verstopfung. Benutzen Sie dazu falls erforderlich einen langen Holzstab (z. B. einen Besenstiel).   |
|   | Filter ist verschmutzt.   | Reinigen Sie den entsprechenden Filter, $\triangleright$ <i>Kapitel 3.2, „Ausblasfiltereinheit reinigen“</i> bzw. $\triangleright$ <i>Kapitel 3.3, „Motorschutzfilter reinigen“</i> .   |
| Saugergebnis ist trotz einwandfreier Funktion nicht zufriedenstellend | Nebenluftregler (Abb. 1/5) ist geöffnet.  | Schließen Sie den Nebenluftregler (Abb. 1/5).   |
|   | Staubfilterbeutel ist überfüllt.  | Wechseln Sie den Staubfilterbeutel $\triangleright$ <i>Kapitel 2.5, „Staubfilterbeutel wechseln“</i> .  |
|   | Düse, Teleskoprohr oder Saugschlauch sind verstopft.                                      | Entfernen Sie die Verstopfung. Benutzen Sie dazu falls erforderlich einen langen Holzstab (z. B. einen Besenstiel).   |
| Gerät läuft ungewöhnlich laut   | Filter ist verschmutzt.   | Reinigen Sie den entsprechenden Filter, $\triangleright$ <i>Kapitel 3.2, „Ausblasfiltereinheit reinigen“</i> bzw. $\triangleright$ <i>Kapitel 3.3, „Motorschutzfilter reinigen“</i> .   |
|   | Eingesaugte Partikel versperren den Luftweg.  | Entfernen Sie die Partikel. Benutzen Sie dazu falls erforderlich einen langen Holzstab (z. B. einen Besenstiel).  |

#### **HINWEIS:**

Wenn Sie das Problem mit Hilfe dieser Tabelle nicht beheben konnten, kontaktieren Sie die Service-Hotline oder den Royal-Kundenservice.

### 4.2 Entsorgung



Die verwendeten Filter sind aus umweltverträglichen Materialien hergestellt und können im Hausmüll entsorgt werden. Wenn das Gebrauchsende erreicht ist, insbesondere, wenn Funktionsstörungen auftreten, machen Sie das ausgediente Gerät unbrauchbar, indem Sie den Stecker aus der Steckdose ziehen und das Stromkabel durchtrennen. Entsorgen Sie das Gerät entsprechend den in Ihrem Land geltenden Umweltvorschriften. Elektrische Abfälle dürfen nicht zusammen mit Haushaltsabfällen entsorgt werden. Wenden Sie sich für Ratschläge bezüglich des Recyclings an Ihre Kommunalbehörde oder Ihren Händler.

### 4.3 Garantiebedingungen

Wir übernehmen für das von uns vertriebene Gerät die gesetzlich vorgeschriebene Gewährleistung von 24 Monaten ab Kaufdatum. Innerhalb dieser Gewährleistungsfrist beseitigen wir nach unserer Wahl durch Reparatur oder Austausch des Gerätes oder des Zubehörs (Schäden an Zubehörteilen führen nicht automatisch zum Umtausch des kompletten Gerätes) unentgeltlich alle Mängel, die auf Material- oder Herstellungsfehlern beruhen. Von der Gewährleistung sind Schäden ausgenommen, die auf unsachgemäßen Gebrauch (Betrieb mit falscher Stromart/-spannung, Anschluss an ungeeignete Stromquellen, Bruch usw.) zurückzuführen sind, normaler Verschleiß und Mängel, die den Wert oder die Gebrauchstauglichkeit des Gerätes nur unerheblich beeinflussen. Bei Eingriffen durch eine nicht von uns autorisierte Stelle oder bei Verwendung anderer als original Royal Appliance-Ersatzteile erlischt die Garantie. Verschleißteile fallen nicht unter die Garantie und sind deshalb kostenpflichtig! Die Gewährleistung tritt nur in Kraft, wenn das Kaufdatum durch Stempel und Unterschrift des Händlers auf der Garantiekarte bestätigt ist oder eine Rechnungskopie dem eingeschickten Gerät beiliegt. Garantieleistungen bewirken weder eine Verlängerung der Garantiezeit, noch beginnt dadurch ein Anspruch auf eine neue Garantie!

### 4.4 Im Garantiefall

Versenden Sie das Gerät ohne Staubfilterbeutel und mit einer kurzen Fehlerbeschreibung in Blockschrift. Versenden Sie das Anschreiben mit dem Vermerk „Zur Garantie“. Senden Sie es zusammen mit der Garantiekarte oder einer Rechnungskopie an folgende Adresse:



**Royal Appliance International GmbH**  
Abt. Kundenservice  
Jagenbergstraße 19  
41468 Neuss - Deutschland

Tel.: +49 (0) 180 - 501 50 50\*  
Fax: +49 (0) 2131 - 60 90 60 95

www.dirtdevil.de; info@dirtdevil.de

\*0,14 €/Minute aus dem deutschen Festnetz  
(deutscher Mobilfunkhöchstpreis 0,42 €/Minute)

**Dirt Devil**  
macht schlauer sauber

**SERVICE-HOTLINE**

**0180 501 50 50\***

In Deutschland stehen wir Ihnen für Fragen, Anregungen oder bei Problemen gerne zur Verfügung.

**Mo.-Fr. 8-20 Uhr**

\* 0,14 €/Min. aus dem deutschen Festnetz  
(deutscher Mobilfunkhöchstpreis 0,42 €/Min.)

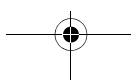



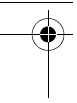

## 1 Overview and safety

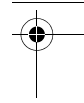

### Thank you!

Thank you for purchasing POPSTER and for your confidence in us.

### Overview

#### Fig. 1:

- 1 a: Dust chamber cover release latch;  
b: Carrying-hole
- 2 Release buttons for the suction hose
- 3 Filter bag change indicator
- 4 Telescopic tube stop catch
- 5 Bypass vent
- 6 Suction power control
- 7 On/Off switch
- 8 Cable retraction button
- 9 Exhaust filter cover release latch
- 10 "Carpet/hard floor" selector

#### Fig. 2:

- 1 Motor protection filter
- 2 Exhaust filter unit consisting of:
- 3 Plastic foam filter element
- 4 Filter holder with sewn-in fleece

#### Fig. 3:

- 1 Paper dust filter bag with holder (inside the appliance)
- 2 one extra paper dust filter bag (in the box)
- 3 Operating Manual

#### Fig. 4:

- 1 Accessory holder
- 2 Upholstery nozzle
- 3 2-in-1 combi nozzle as crevice nozzle
- 4 2-in-1 combi nozzle as furniture brush

#### Fig. 5:

\* optional accessories:

- 1 \*Parquet brush (M203): for vacuuming delicate surfaces (e.g. laminate, parquet)
- 2 \*Turbo brush (M209): for thoroughly deep cleaning of carpets with the revolving brush head.

### Technical data

|                   |                                   |
|-------------------|-----------------------------------|
| Type of appliance | : Cylinder Vacuum Cleaner         |
| Model             | : POPSTER M7012 (-0/.../-9)       |
| Voltage           | : 220 – 240 V~, 50/60 Hz          |
| Power             | : 1,400 W nom.– 2,000 W max.      |
| Dust bag capacity | : max. usable capacity 1.5 litres |
| Power cord length | : approx. 5 m                     |
| Weight            | : approx. 4.5 kg                  |



Technical and design specifications may be changed in the course of continuous product improvement.  
© Royal Appliance International GmbH

### 1.1 Re: Operating Manual

Read this operating manual completely before working with the appliance. Keep the operating manual for reference. Include the operating manual if you pass the appliance on to someone else.

Important notes for your safety are especially marked. Always observe these notices to avoid accidents and damage to the appliance.

**WARNING:**  
Warning concerning health hazards describing possible risks of injury.

**ATTENTION:**  
Warning concerning possible dangers to the appliance or other objects.

**NOTE:**  
Highlights tips and information for you.

GB

**Non-compliance with these instructions can lead to serious injuries or damage to the appliance.**

We take no responsibility for damages due to violations of these operating instructions.

### 1.2 Re: Children

■ This appliance is not intended to be used by persons (including children) with impaired physical, sensorial or mental abilities and/or insufficient experience or knowledge, unless they are supervised by a person responsible for their safety or have been instructed in the proper use of the appliance by this person. Children should be supervised in order to make sure that they don't play with the appliance. Keep the appliance out of reach of people of these groups.

■ Packing material must not be used to play with. There is danger of suffocation.

### 1.3 Re: Appropriate Use

- The cylinder vacuum cleaner is intended for home use only. It is not suitable for commercial use.
- Only use the cylinder vacuum cleaner for cleaning dry, normally soiled floors, rugs and curtains.

**Any other use is considered inappropriate and is prohibited.**

**It is especially forbidden:**

- To vacuum-clean:
  - people and animals. Parts of their body could be sucked in and injured.
  - clothing worn on people's bodies. They could be sucked in and cause injuries.
  - water and other fluids, especially damp carpet cleaning agents. Moisture inside the appliance can cause a short circuit.
  - toner dust (for laser printers, copying machines, etc.). There is danger of fire or explosion.
  - hot ash, burning cigarettes or matches. This could cause a fire.
  - pointed objects, such as glass shards, nails, etc. They can damage the appliance.
  - rubble, plaster, cement, fine drilling-dust, makeup, etc. These might damage the appliance.
- To use the appliance near explosive or easily flammable substances. There is danger of fire or explosion.
- Outdoor use. There is danger of rain and dirt destroying the appliance.
- Sticking objects into the appliance's openings. There is a danger of injury.
- To modify or repair the appliance on your own. There is a danger of injury.

### 1.4 Re: Power supply

■ The appliance runs on electricity -- that means there is a general risk of electric shock. So please especially observe the following:

- Never touch the plug with wet hands.
- Always pull directly at the plug if you want to disconnect the appliance from the mains. Never pull the power cord, it might break.
- Take care that the power cord is not bent, pinched, rolled over or gets in contact with heat sources.
- Only use extension cords of sufficient capacity for the power requirement of the appliance.
- Never immerse the appliance in water or other liquids. Keep it away from rain and moisture.
- Only operate the appliance if your mains voltage is the same as that indicated on the appliance's type plate. Wrong voltage can destroy the appliance.

### 1.5 If the appliance is defective

■ Never use a defective appliance or operate an appliance with a defective power cord. If the power cord of this appliance is damaged it must be replaced by the manufacturers, their authorised service representative or a similarly qualified person to avoid danger.

■ Refer a defective appliance to an authorised dealer or the Royal Appliance service for repair. Address: [page 40, „International Service“](#).

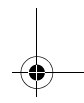
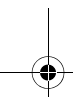

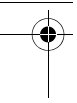

## 2 Operation

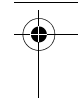

### 2.1 Unpacking and assembling

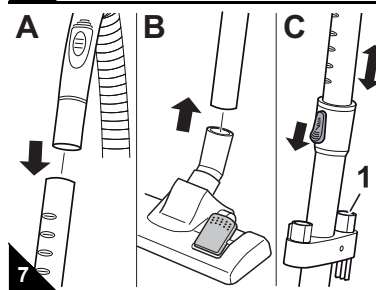
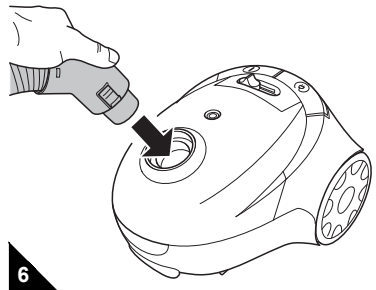

1. Unpack the appliance with all its accessories.
2. Check that the contents are complete and intact (Fig. 1–5).

**NOTE:**

Immediately contact your dealer if you have found damage resulting from transport.

**⚠ ATTENTION:**

Always transport or ship the appliance in its original packaging to avoid damage. Keep the packaging for such an event. Dispose of no longer needed packaging material properly.

**⚠ WARNING:**

Danger of injury! Only assemble the appliance if it is not connected to the power supply. Otherwise the machine might start up and parts of your body, hair or pieces of clothing might be sucked in.

3. Insert the end of the suction hose into the intake opening as shown until you hear and feel it lock into place (Fig. 6).
4. Insert the handle into the upper end of the telescopic tube (Fig. 7/A).
5. Push the desired nozzle onto the lower end of the telescopic tube (Fig. 7/B).
6. Adjust the length of the telescopic tube. Press down the release latch on the telescopic tube (Fig. 7/C) to do this. Then extend the telescopic tube to the desired length. Let go of the release latch while pulling until it locks in place. You will hear a distinct click.
7. Attach accessories you don't need at the moment to the accessory holder (Fig. 7/C1), as shown. Your cylinder vacuum cleaner is now ready for use.

### 2.2 Vacuum cleaning

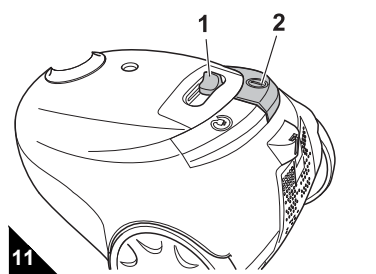
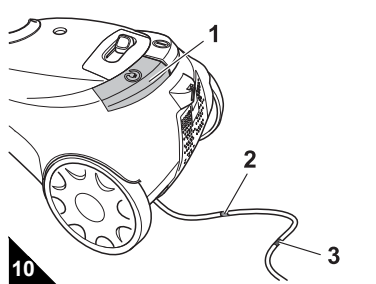
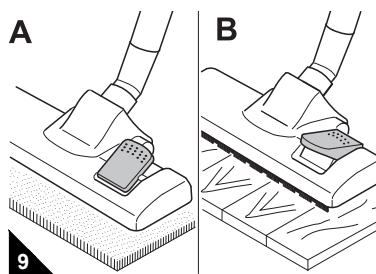
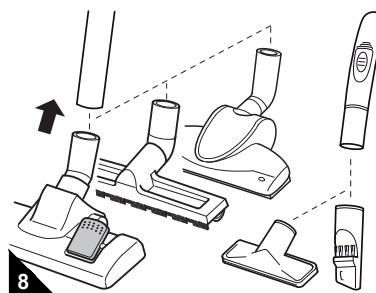

**⚠ WARNING:**

Danger of injury! A damaged appliance must never be used. Check the cylinder vacuum cleaner and the power cord before each use.

**⚠ WARNING:**

Danger of injury! Especially when vacuum-cleaning stairs make sure that you are always on a higher level than the appliance.

**⚠ ATTENTION:**

Only use the cylinder vacuum cleaner with all filters intact, dry and correctly fitted. Make sure that no openings are clogged. Otherwise the vacuum cleaner might be damaged.

**NOTE:**

Your cylinder vacuum cleaner is equipped with a safety switch to prevent overheating. It automatically cuts off the power supply if the motor is overheated. In this case switch off the appliance and disconnect it from the mains. Remove the cause of the overheating. Wait for about 45 minutes. After it has cooled off, you may use the cylinder vacuum cleaner again.

1. Attach the desired nozzle, (Fig. 8).

**⚠ ATTENTION:**

Please follow the flooring manufacturers' recommendations if you are not sure which nozzle is suitable for your flooring.

2. If using the floor nozzle, set the "carpet/hard floor" selector to suit the type of flooring:
  - **Carpet (Fig. 9/A):** for short- and deep-pile carpets, runners, etc.
  - **Hard floor (Fig. 9/B):** for laminate, tiles, PVC, etc.
3. Pull out the power cord by the plug up to the yellow mark (Fig. 10/3).

**⚠ WARNING:**

Danger of electric shock! If the red mark (Fig. 10/2) shows, retract the cord by pressing the retract button (Fig. 10/1) to pull in the cable up to the yellow mark (Fig. 10/3) again. Otherwise, the power cord may be damaged.

4. Insert the mains plug into a socket with ground/safety contact.
5. Switch on the cylinder vacuum cleaner with the on/off switch (Fig. 11/2).
6. Set the suction power control (Fig. 11/1) to suit the surface to be cleaned.
7. When working with the cylinder vacuum cleaner, pull it after you like a sleigh.

**NOTE:**

With the bypass vent (Fig. 1/5) you can quickly reduce the suction power if less power is needed, e.g. to release objects accidentally sucked in.

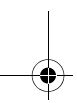

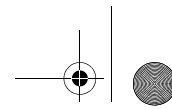

## 2 Operation

**Royal**

### 2.3 Switching off

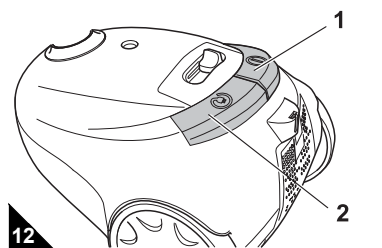

1. Switch off the cylinder vacuum cleaner with the on/off switch (Fig. 12/1) and pull the plug from the mains socket.
2. Keep the plug in your hand.

**⚠ WARNING:**

Danger of injury! During uncontrolled retraction the power cord can whip around, become an obstacle or overthrow objects. Therefore keep the plug in your hand and guide it during retraction of the power cord.

3. Push the cord retracting button (Fig. 12/2) to retract the power cord.

### 2.4 Transportation and storage

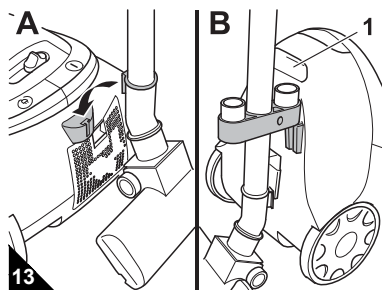

- To **transport** the appliance you can carry it by the carrying-hole (Fig. 13/B1).
- When **interrupting your work** you can hang the parking-hook onto the parking bracket (Fig. 13/A).
- For **storing the appliance** you can hook the storage hook onto the storage bracket (Fig. 13/B).
- It is recommended to first retract the telescopic tube ▷ *chapter 2.1, „Unpacking and assembling“*, step 4.

**⚠ ATTENTION:**

Never store the appliance next to heat sources (e.g. stoves or radiators). Avoid exposing it to direct sunlight. Heat can damage the appliance.

- Before **storing** it for a prolonged time remove the dust filter bag and dispose ▷ *chapter 2.5, „Changing the dust filter bag“* of it properly. Always store the appliance in a cool, dry place and out of reach of children.

### 2.5 Changing the dust filter bag

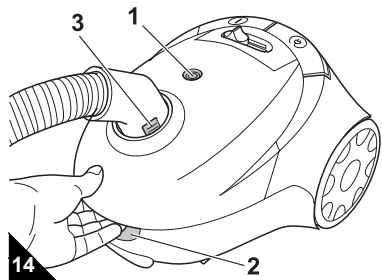
**⚠ ATTENTION:**

Switch off the appliance before removing the dust filter bag. This will prevent dust from damaging the appliance.

- Change the dust filter bag when the filter bag changing indicator (Fig. 14/1) shows "red," before prolonged storage or for re-shipment of the appliance.
- Change the dust filter bag at least every three months for hygienic reasons.

1. Switch off the appliance and pull the plug from the mains socket, ▷ *chapter 2.3, „Switching off“*.
2. Open the dust compartment cover by pushing the release latch (Fig. 14/2) and then lifting the cover.
3. Lift the dust compartment cover until it locks in the highest position and remains open by itself.

**NOTE:**

If the dust compartment cover will not stay open by itself, we recommend to take off the suction hose. To do this, push both release buttons (Fig. 14/3) and pull the suction hose out of the intake opening.

4. Pull the dust bag holder together with the dust filter bag up and out of the appliance (Fig. 15) as shown.

**NOTE:**

Be careful when removing the dust filter bag so that no dust escapes.

5. Pull the full dust filter bag up and out of the dust filter bag holder (Fig. 16).

**NOTE:**

You can dispose of the dust filter bag with your regular domestic trash as long as it contains no waste materials prohibited in domestic trash.

6. Push the new dust filter bag into the filter bag holder as shown until it flushes exactly with the edge of the filter bag holder behind the two tabs, (Fig. 16, arrows).

7. Remove any dust that may have collected in the dust compartment.

8. Also check the dual motor protection filter on this occasion. Change it if necessary, ▷ *chapter 3.3, „Cleaning the motor protection filter“*.

9. Put the dust bag holder with the new dust filter bag back into the appliance:

- Do this by inserting the dust bag holder into the respective guide-rails (Fig. 17/arrows).
- Then push the dust bag holder down until it lies securely on its guide.

**NOTE:**

The dust chamber cover can only be closed if the dust filter bag is correctly fitted.

10. Close the dust compartment cover. It snaps shut.

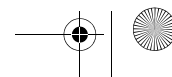
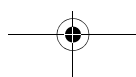
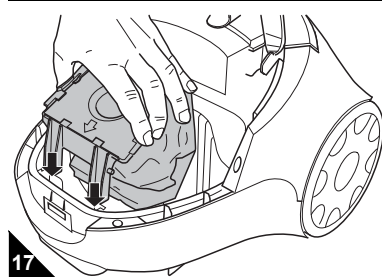
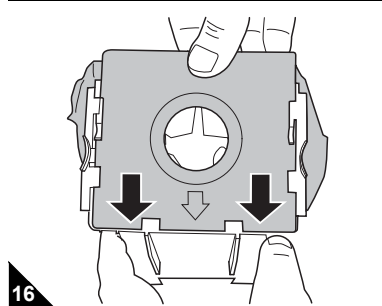
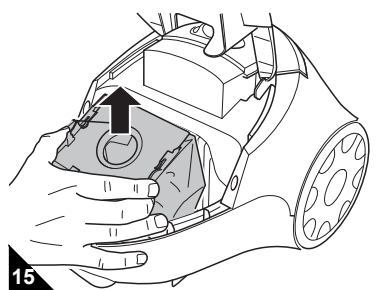



## 3 Maintenance



### 3.1 Overview of the filters

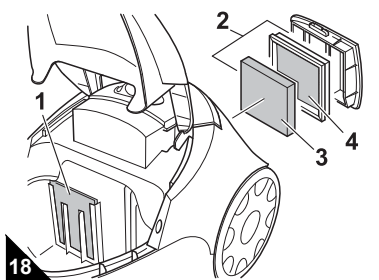

The filters can get dirty during use and therefore must be checked regularly:

The following filters are installed:

■ **Motor protection filter (Fig. 18/1)**

It prevents larger particles from damaging the motor in case the dust filter bag is defective.

- Changing: after each 5th change of the dust filter bag, at the latest every 6 months (▷chapter 3.3, „Cleaning the motor protection filter“).

■ **Exhaust filter unit (Fig. 18/2) consisting of:**

- Foam plastic filter element (Fig. 18/3) and
- Filter holder with sewn-in fleece (Fig. 18/4)

The exhaust filter unit filters finest dust particles from the exhaust air stream.

- Changing: every 6 months (▷chapter 3.2, „Cleaning the exhaust filter unit“).

### 3.2 Cleaning the exhaust filter unit

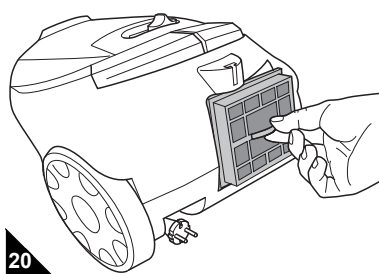
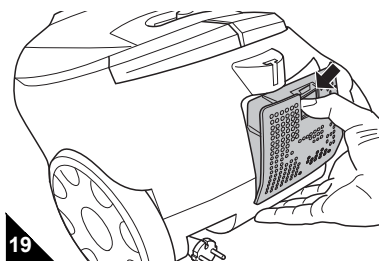

1. Switch off the vacuum cleaner and pull the plug from the mains socket, ▷chapter 2.3, „Switching off“.
2. Push down the release latch of the exhaust filter cover and fold down the exhaust filter cover (Fig. 19).
3. Remove the exhaust filter unit from its receptacle by pulling the tab provided (Fig. 20).
4. Hold the exhaust filter unit low over a dustbin.
5. Remove the foam plastic filter element from the filter holder.
6. Thoroughly rinse both filter elements by hand with clear cold water.

**⚠ ATTENTION:**

The filter elements of the exhaust filter unit are washable, but not suitable for cleaning in washing machines or dishwashers. Also, do not use cleansers for cleaning the filters. Then leave the filter elements to dry (approx. 24 hours at room temperature). Only put them back into the appliance when they are completely dry.

7. If a filter element is damaged or deformed, replace it by a new one (▷chapter 3.4, „Accessories and Spare Parts“).
8. Put the cleaned or new foam plastic filter element back into the filter holder.
9. Now put the filter holder with the freshly fitted filters back into its receptacle (Fig. 20). Make sure that the tab for removing the filter holder shows towards the outside of the appliance.
10. Attach the exhaust filter cover at the bottom side first and then push in the upper side until you feel it locking into place (Fig. 19).

### 3.3 Cleaning the motor protection filter

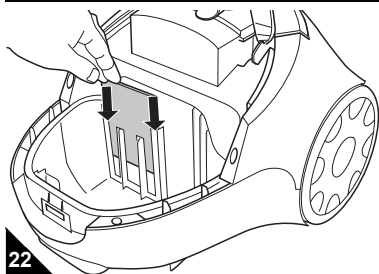
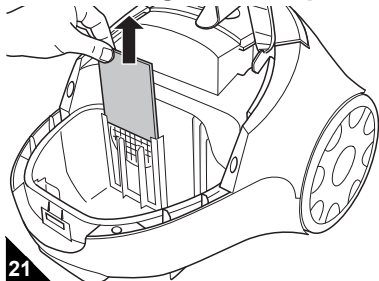

1. Switch off the appliance and remove the dust bag holder complete with the dust filter bag, ▷chapter 2.5, „Changing the dust filter bag“, steps 1–4.
2. Remove the motor protection filter by pulling it upwards out of its guiderails (Fig. 21).
3. Thoroughly rinse the motor protection filter by hand with clear cold water.

**⚠ ATTENTION:**

The motor protection filter is washable, but not suitable for cleaning in washing machines or dishwashers. Also, do not use cleansers for cleaning the filter. Then leave the motor protection filter to dry (approx. 24 hours at room temperature). Only put it back into place when it is completely dry.

4. If the motor protection filter is damaged or deformed, replace it with a new one. (▷chapter 3.4, „Accessories and Spare Parts“).
5. Push the motor protection filter back into its respective guiderails (Fig. 22/arrows).
6. Insert the dust bag holder with the dust filter bag and close the dust compartment cover. It snaps shut.

### 3.4 Accessories and Spare Parts

| Item number | Description   |
|-------------|---|
| 7010022     | Set of 5 dust filter bags and 1 motor protection filter   |
| 7011002     | 1 exhaust filter unit (incl. Foam plastic filter element (Fig. 18/3) and filter holder (Fig. 18/4)) |
| M203        | 1 parquet brush   |
| M209        | 1 turbo brush   |

### 3.5 Sources

■ Ordering address ▷page 40, „International Service“.

■ Further information is available at <http://www.dirtdevil.de>

### 3.6 Recommendation



We recommend: Swirl® Y05 dust filter bags with MicroPor® filtration

**NOTE:**

Insert bag in direction "C."

Swirl®, MicroPor® and "Y05" are registered trade marks of a company of the Melitta group and used with their permission.





## 4 Troubleshooting



### 4.1 Before you send in the appliance

Before contacting your authorised Royal dealer, Royal service partner or appliance market, first follow the procedure in the following table to check if you can handle the problem yourself

**WARNING:**

Danger of injury! Never use a defective appliance! Always switch off the appliance and disconnect it from the mains before starting troubleshooting  
▷ *chapter 2.3, „Switching off“.*

| Problem   | Possible cause  | Solution  |
|---|---|---|
| The appliance will not start.   | The power cord is not plugged in.   | Insert the plug into a mains socket and switch on the appliance ▷ <i>chapter 2.2, „Vacuum cleaning“.</i>  |
|   | The socket does not carry current.  | Test the cylinder vacuum cleaner at another socket which you are sure carries current.  |
|   | Power cord is damaged.  | Have the power cord replaced by Royal Appliance Customer Service, address, ▷ <i>page 40, „International Service“.</i>   |
| The vacuum cleaner stops suddenly.  | The overheating protection has tripped (possibly due to blocked suction channels, filters, or similar). | Switch the appliance off and pull the plug out of the socket. Eliminate the cause of overheating (e.g. blocked suction channels, filters, etc.). Wait for about 45 minutes. After the appliance has cooled off, you may switch it on again. |
| Dust filter changing indicator shows "red".                                 | The dust container is full.   | Change the dust filter bag ▷ <i>chapter 2.5, „Changing the dust filter bag“</i>   |
|   | Nozzle, telescopic tube or suction hose are clogged.  | Remove the obstacle. If necessary, use a long wooden stick (e.g. a broomstick) to do this.  |
|   | The filter is dirty.  | Clean the respective filter, ▷ <i>chapter 3.2, „Cleaning the exhaust filter unit“</i> or ▷ <i>chapter 3.3, „Cleaning the motor protection filter“.</i>  |
| The results are unsatisfactory in spite of the appliance working correctly. | Bypass vent (Fig. 1/5) is open.   | Close the bypass vent (Fig. 1/5).   |
|   | The dust container is full.   | Change the dust filter bag ▷ <i>chapter 2.5, „Changing the dust filter bag“</i>   |
|   | Nozzle, telescopic tube or suction hose are clogged.  | Remove the obstacle. If necessary, use a long wooden stick (e.g. a broomstick) to do this.  |
|   | The filter is dirty.  | Clean the respective filter, ▷ <i>chapter 3.2, „Cleaning the exhaust filter unit“</i> or ▷ <i>chapter 3.3, „Cleaning the motor protection filter“.</i>  |
| The appliance's noise is unusually loud.                                    | Sucked-in objects are obstructing the air stream.   | Remove the objects. If necessary, use a long wooden stick (e.g. a broomstick) to do this.   |

GB

**NOTE:**

If you cannot solve the problem following these instructions, contact our service hotline or the Royal Customer Service (▷ *page 40, „International Service“*).

### 4.2 Disposal



The filters used are made of environment-friendly materials and can be disposed of with your domestic trash. When the appliance has reached the end of its usefulness, especially if dysfunctions recur, disable the useless appliance by pulling the mains plug out of the socket and cutting off the power cord. Dispose of the appliance in compliance with the environmental protection laws of your country. Electrical waste may not be disposed of together with domestic waste. Consult your local authorities or your dealer for advice on recycling.

### 4.3 Conditions of warranty

**We grant the legally required 24 months warranty from the date of purchase for the appliance distributed by us.**

Within this period we will either repair or replace the appliance or accessory (damages to accessories do not automatically cause a replacement of the complete appliance) all defects due to manufacturing or materials at no cost. The warranty does not cover damage due to improper use (operating on the wrong power type/voltage, connecting to unsuitable power sources, breakage, etc.), normal wear and defects that only insignificantly affect the value or the serviceability of the appliance. Intrusions by unauthorised parties and the use of spare parts not supplied by Royal Appliance invalidate the warranty. Consumable parts are not included in the warranty and must be paid for! The warranty is only valid if the date of purchase has been acknowledged by the dealer's stamp and signature on the warranty card or if a copy of the invoice or sales slip is included with the sent-in appliance. Warranty work does not extend the warranty period nor does it constitute a claim for a new warranty!

### 4.4 In case of a warranty claim

Send us the appliance without dust filter bag and a short description of the fault in printed letters. Head your accompanying letter with the notice "warranty claim". Send it to the address on the back page (▷ *page 40, „International Service“*) of this operating manual, including the warranty card or a copy of the purchase slip.

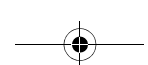



## 1 Vue d'ensemble et sécurité



### Merci beaucoup !

Nous vous remercions de l'achat de ce POPSTER et de votre confiance.

### Aperçu (Ill. 1) :

- 1 a : Déverrouillage du couvercle du compartiment à poussière  
b : Poignée de transport
- 2 Touche de déverrouillage du tuyau d'aspiration
- 3 Indicateur de remplacement du sac-filtre à poussière
- 4 Arrêt du tube télescopique
- 5 Variateur mécanique de puissance
- 6 Variateur de puissance d'aspiration
- 7 Interrupteur marche/arrêt
- 8 Bouton de l'enrouleur
- 9 Déverrouillage du couvercle du filtre de sortie d'air
- 10 Commutateur « Tapis/sols durs »

### III. 2 :

- 1 Filtre de protection du moteur
- 2 Unité de filtre de sortie d'air se composant de :
  - 3 Élément de filtre en mousse
  - 4 Support de filtre avec non-tissé cousu

### III. 3 :

- 1 Sac-filtre à poussière en papier avec support (dans l'appareil)
- 2 un autre sac-filtre à poussière en papier (se trouve dans l'emballage)
- 3 Mode d'emploi

### III. 4 :

- 1 Support pour accessoires
- 2 Suceur pour coussins et tissus capitonnés
- 3 Brosse 2 en 1 servant de suceur long
- 4 Brosse 2 en 1 servant de brosse à meubles

### III. 5 :

*\*accessoires en option :*

- 1 *\*brosse pour parquets (M203) :*  
*convient aux surfaces qu'il faut ménager (comme par exemple les parquets ou les sols stratifiés)*
- 2 *\*turbobrosse (M209) :*  
*pour un nettoyage en profondeur des tapis avec une brosse à tête rotative*

### Caractéristiques techniques

Type d'appareil : Brosse universelle  
 Modèle : **POPSTER, M7012** (-0/.../-9)  
 Tension : 220 – 240 V~, 50/60 Hz  
 Puissance : 1'400 W nom. – 2'000 W max.  
 Volume du sac à poussière : Capacité maximale utile de 1,5 litres  
 Longueur du cordon d'alimentation : env. 5 m  
 Poids : env. 4,5 kg



Toutes modifications d'ordre technique ou conceptuel liées à l'évolution du produit sont réservées.  
© Royal Appliance International GmbH

### 1.1 En rapport avec ce mode d'emploi

Veillez lire attentivement et intégralement ce mode d'emploi avant de vous servir de l'appareil. Conservez avec soin ce mode d'emploi. Remettez toujours le mode d'emploi à toute personne se servant de l'appareil. Les consignes importantes pour votre sécurité sont particulièrement mises en évidence. Respectez impérativement ces consignes afin d'éviter tout accident ou dommage à l'appareil :

#### **AVERTISSEMENT:**

Nous attirons votre attention sur les dangers pouvant mettre en péril votre santé et vous informons sur les éventuels risques de blessures.

#### **ATTENTION:**

Nous vous rendons attentifs aux risques éventuels pour l'appareil ou pour tout autre objet.

#### **REMARQUE:**

Nous vous donnons des conseils et des informations.

**Le non respect de ce mode d'emploi peut entraîner des blessures graves ou des dommages irréparables à l'appareil.**

Nous déclinons toute responsabilité pour des dommages résultant du non respect de ce mode d'emploi.

### 1.2 Remarques par rapport aux enfants

- Les personnes (y compris les enfants) qui ne sont pas en mesure de se servir de manière sûre de l'appareil, en raison de leurs capacités physiques ou sensorielles, de leurs capacités mentales, de leur inexpérience ou d'un manque de connaissances, ne doivent pas utiliser cet appareil sans surveillance ou sans bénéficier d'indications de fonctionnement données par une personne responsable. Les enfants doivent être surveillés afin de s'assurer qu'ils ne jouent pas avec l'appareil. Rangez l'appareil hors de portée des personnes répondant à ces critères.
- Ne jouez pas avec le matériel d'emballage : il existe un risque d'asphyxie.

### 1.3 Remarques par rapport aux conditions d'utilisation

- Cet aspirateur-traîneau doit seulement être utilisé dans un cadre domestique. Toute utilisation à titre professionnel est strictement interdite.
- Cet aspirateur-traîneau doit uniquement servir à nettoyer des sols secs d'un degré de saleté normal, des moquettes et tapis ainsi que des rideaux.

**Toute autre utilisation est considérée comme non conforme et est interdite.**

**Cette interdiction concerne en particulier :**

- L'aspiration :
  - de parties du corps et d'animaux. Ils peuvent être aspirés et entraîner des blessures graves.
  - de parties de vêtements se trouvant sur le corps. Elles peuvent être aspirées et entraîner des blessures.
  - d'eau ou d'un autre liquide, en particulier les produits de nettoyage humides pour tapis. Toute humidité à l'intérieur de l'appareil peut entraîner un court-circuit.
  - de poussière de toner (par ex. pour des imprimantes laser, des copieurs, etc.). Il y a un risque d'incendie et d'explosion.
  - de cendres incandescentes, de cigarettes ou d'allumettes non éteintes. Il y a un risque d'incendie.
  - d'objets pointus comme des bris de verre, des clous etc. Ces objets détruisent les filtres.
  - de gravats de chantier, de plâtre, de ciment, de fines poussières de perçage, de produits de maquillage, etc. Cela peut endommager l'appareil.
- En cas d'utilisation à proximité de matières explosives ou facilement inflammables. Il y a un risque d'incendie et d'explosion.
- A l'air libre la pluie et la saleté peuvent occasionner des dommages irréparables à l'appareil.
- L'introduction d'objets dans les ouvertures de l'appareil, car il y a un risque de blessure.
- Toute modification ou réparation de l'appareil. Il y a un risque de blessure.

### 1.4 Remarques par rapport à l'alimentation électrique

■ L'appareil est alimenté par du courant électrique, ce qui implique par principe un risque d'électrocution. Respectez par conséquent les points ci-dessous :

- ne touchez jamais la prise avec des mains mouillées.
- pour débrancher l'appareil, tirez toujours sur la fiche. ne tirez jamais sur le cordon d'alimentation car il pourrait se rompre.
- assurez-vous que le cordon d'alimentation n'est pas plié, coincé, écrasé ou encore en contact direct avec une source de chaleur.
- utilisez toujours une rallonge dont la consommation électrique correspond à celle de l'appareil.
- ne plongez jamais l'appareil dans de l'eau ou tout autre liquide, conservez-le à l'abri de la pluie et de l'eau.
- n'utilisez l'appareil que si la tension indiquée sur la plaque signalétique correspond bien à celle de votre prise. Une tension incorrecte pourrait rendre l'appareil définitivement inutilisable.

### 1.5 En cas de défectuosité de l'appareil

■ N'utilisez jamais un appareil défectueux ou ayant un cordon d'alimentation abîmé. Si le cordon de raccordement au secteur de cet appareil est endommagé, faites-le remplacer par le fabricant, son service après-vente ou toute personne ayant des compétences similaires, ceci afin d'éviter tout danger.

■ Amenez l'appareil à réparer dans un magasin spécialisé ou au service après-vente Royal Appliance.

Adresse ▷ Page 40, „International Service“.

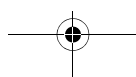

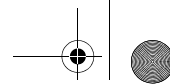

## 2 Emploi

**Royal**



### 2.1 Déballage et montage

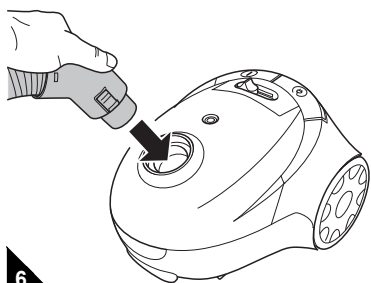

6

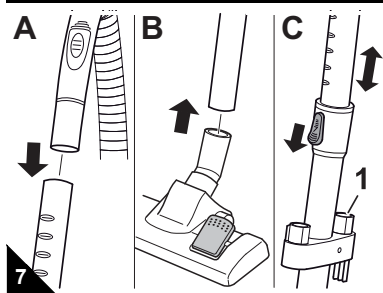

7

1. Déballez l'appareil ainsi que les accessoires.
2. Vérifiez si le contenu est bien complet et ne présente aucuns dommages (ill. 1-5).

#### REMARQUE:

Si vous constatez des défauts ou des dommages dus au transport, contactez immédiatement votre revendeur.

#### ⚠ ATTENTION:

Transportez et expédiez l'appareil uniquement dans son emballage d'origine afin d'éviter tout dommage. Conservez à cet effet soigneusement l'emballage d'origine. Jetez en revanche les emballages dont vous n'avez plus besoin en tenant compte des réglementations en vigueur.

#### ⚠ AVERTISSEMENT:

Risque de blessures ! Montez l'appareil seulement quand la fiche est retirée de la prise. L'appareil peut sinon se mettre en marche et des cheveux, des parties du corps ou des pièces de vêtements peuvent étre aspirés.

3. Emboîtez l'extrémité du flexible d'aspiration comme illustré dans l'ouverture du logement jusqu'à nettement entendre et percevoir un "clic" (ill. 6).
4. Emboîtez la poignée dans l'extrémité supérieure du tube télescopique (ill. 7/A).
5. Emboîtez la brosse ou le suceur souhaités sur le tube télescopique (ill. 7/B).
6. Réglez la longueur du tube télescopique. Pour ce faire, poussez vers le bas l'arrêt du tube télescopique (ill. 7/C). Tirez ensuite le tube télescopique jusqu'à atteindre la longueur souhaitée. Pour procéder au verrouillage, relâchez l'arrêt du tube télescopique pendant que vous le tirez. Vous entendez alors clairement un "clic".
7. Placez les accessoires dont vous n'avez éventuellement plus besoin dans le support pour accessoires (ill. 7/C1) en bas.

Votre aspirateur-traîneau est maintenant prêt à l'emploi.

### 2.2 Utilisation de l'aspirateur

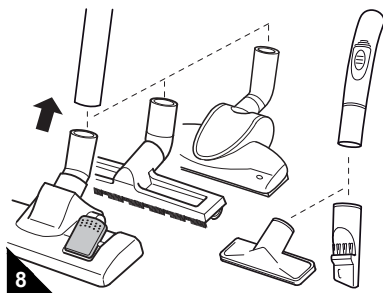

8

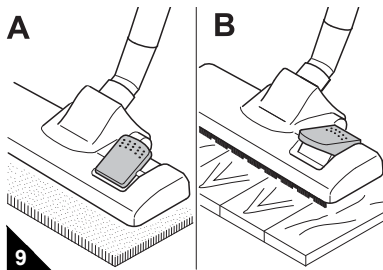

9

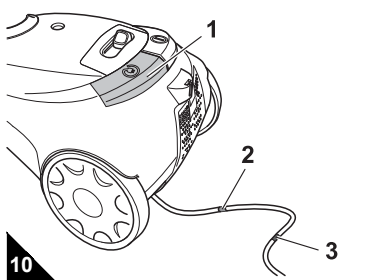

10

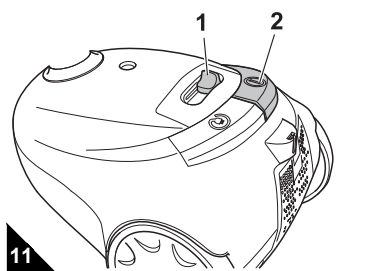

11

#### ⚠ AVERTISSEMENT:

Risque de blessures ! N'utilisez jamais un appareil qui est endommagé. Avant tout emploi, vérifiez l'aspirateur et le cordon d'alimentation.

#### ⚠ AVERTISSEMENT:

Risque de blessures ! Lors d'une aspiration dans des escaliers, prenez garde à ce que vous vous trouviez toujours au-dessus de l'appareil.

#### ⚠ ATTENTION:

N'utilisez l'aspirateur que lorsque tous les filtres sont en parfait état, secs et bien insérés. Assurez-vous qu'aucune ouverture n'est bouchée. Autrement, vous risquez d'endommager l'aspirateur.

#### REMARQUE:

Votre aspirateur est équipé d'une protection anti-surchauffe. Il s'arrête automatiquement en cas de surchauffe. Dans ce cas, éteignez l'aspirateur et débranchez-le. Recherchez la cause de la surchauffe. Attendez environ 45 minutes. Une fois l'aspirateur refroidi, vous pouvez le remettre en marche.

1. Emboîtez le suceur voulu (ill. 8).

#### ⚠ ATTENTION:

Respectez les recommandations des fabricants de revêtements et assurez-vous que le suceur ou la brosse utilisés conviennent à chaque type de sol.

2. En cas d'utilisation du suceur de sol, réglez le commutateur « moquettes / sols durs » ) suivant le revêtement du sol :
  - **Tapis (ill. 9/A)** : pour moquettes et tapis à poils longs et courts, tapis d'escalier, etc.
  - **Sols durs (ill. 9/B)** : pour sols stratifiés, carrelage, linoléums, etc.
3. Tirez le cordon d'alimentation jusqu'à ce que la marque jaune soit visible (ill. 10/3).

#### ⚠ AVERTISSEMENT:

Risques d'électrocution ! Si la marque rouge (ill. 10/2) est visible, rentrez à nouveau le cordon à l'aide du bouton de l'enrouleur (ill. 10/1) jusqu'à ce que la marque jaune (ill. 10/3) soit visible. Vous risquez sinon d'endommager le cordon d'alimentation.

4. Branchez la fiche dans une prise de courant munie d'un contact de protection.
5. Appuyez sur le bouton marche/arrêt (ill. 11/2) afin de mettre l'aspirateur en marche.
6. Emboîtez la brosse ou le suceur voulu (ill. 11/1) selon le type de sol qui doit étre aspiré.
7. Pour passer l'aspirateur, tirez-le derrière vous comme un traîneau.

#### REMARQUE:

En vous servant du variateur mécanique de puissance (ill. 1/5), vous pouvez réduire rapidement la puissance d'aspiration lorsqu'une puissance d'aspiration inférieure est requise, par exemple pour dégager les objets qui auraient été aspirés.

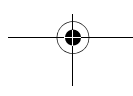
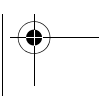

## 2 Emploi

### 2.3 Arrêt de l'appareil

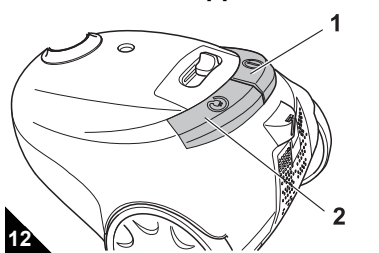

1. Éteignez l'aspirateur au moyen du bouton marche/arrêt (ill. 12/1), puis débranchez-le.
2. Gardez la fiche en main.

#### **⚠ AVERTISSEMENT:**

Risque de blessures ! En enroulant trop rapidement le cordon d'alimentation, celui-ci peut onduler et faire trébucher des personnes ou arracher des objets. Gardez donc la fiche en main et accompagnez le cordon lors de son enroulement.

3. Appuyez sur le bouton de l'enrouleur (ill. 12/2) pour enrouler le cordon d'alimentation.

### 2.4 Transport et rangement

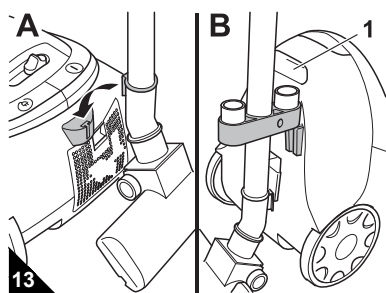

- Lors du **transport**, vous pouvez porter l'appareil par sa poignée (ill. 13/B) .
- Pendant les **pauses**, vous pouvez placer le crochet de rangement dans la fixation prévue à cet effet (ill. 13/A).
- Pour le **rangement de l'appareil** vous pouvez placer le crochet de rangement dans le support de rangement (ill. 13/B).
- Il est recommandé de rétracter préalablement le tube télescopique ▷ *Chapitre 2.1, „Déballage et montage“*, étape 4.

#### **⚠ ATTENTION:**

Ne posez jamais l'appareil à proximité immédiate d'une source de chaleur (par exemple un chauffage ou un four). Évitez de l'exposer directement aux rayons du soleil. La chaleur peut endommager l'appareil.

- Pour le **rangement de l'appareil durant une longue période**, retirez le sac-filtre à poussière ▷ *Chapitre 2.5, „Remplacement du sac-filtre à poussière“* et jetez-le à un emplacement approprié. Rangez toujours l'appareil à un emplacement frais et sec qui soit hors de portée des enfants.

### 2.5 Remplacement du sac-filtre à poussière

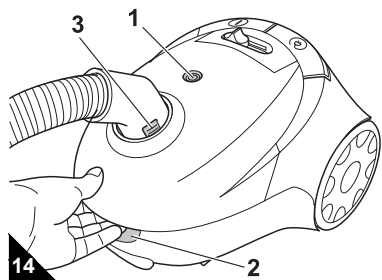

#### **⚠ ATTENTION:**

Avant de changer le sac-filtre à poussière, éteignez l'appareil. Vous évitez ainsi que la poussière n'endommage l'appareil.

- Remplacez le sac-filtre à poussière au plus tard lorsque l'affichage de changement du sac-filtre à poussière (ill. 14/1) est sur « rouge », avant une longue période d'inutilisation ou avant de l'envoyer par la poste.
- De plus, pour des raisons d'hygiène, changez le sac-filtre à poussière au plus tard tous les trois mois.

1. Éteignez l'appareil et débranchez-le, ▷ *Chapitre 2.3, „Arrêt de l'appareil“*.
2. Ouvrez le couvercle du compartiment à poussière tout d'abord en appuyant sur la touche de déverrouillage (ill. 14/2) puis en relevant ensuite le couvercle.
3. Relevez le couvercle du compartiment de poussière jusqu'à entendre un déclic et que le couvercle reste ouvert de lui-même.

#### **REMARQUE:**

Au cas où le couvercle du compartiment à poussière ne resterait pas ouvert de lui-même, il est recommandé de retirer auparavant le tuyau d'aspiration. Enfoncez pour cela la touche de déverrouillage (ill. 14/3) puis retirez le tuyau d'aspiration de son logement.

4. Retirez le support du sac à poussière avec le sac-filtre à poussière (ill. 15) vers le haut comme indiqué sur l'illustration.

#### **REMARQUE:**

Retirez le sac-filtre à poussière avec prudence afin d'éviter que la poussière ne s'échappe de ce dernier.

5. Retirez l'ensemble du sac-filtre à poussière vers le haut en le sortant du support du sac à poussière (ill. 16).

#### **REMARQUE:**

Le contenu du bac à poussière peut être mis à la poubelle s'il ne contient pas de salissures qui ne doivent pas être jetées dans les ordures ménagères.

6. Insérez un nouveau sac-filtre à poussière, comme indiqué sur l'illustration, dans le support du sac à poussière jusqu'à ce qu'il se trouve derrière les deux tenons et précisément sur l'arête du support du sac à poussière (ill. 16, flèches).
7. Enlevez les résidus de poussière se trouvant éventuellement dans le compartiment à poussière.
8. Profitez de cette occasion pour contrôler le filtre de protection du moteur. Changez-le au besoin, ▷ *Chapitre 3.3, „Nettoyage du filtre de protection du moteur“*.
9. Remettez en place le nouveau sac-filtre à poussière avec le support du sac à poussière :
  - Insérez pour cela le support du sac à poussière dans les deux rails de guidage prévus à cet effet (ill. 17/ flèches).
  - Exercez une pression suffisante vers le bas sur le support du sac-filtre à poussière jusqu'à ce que celui-ci se trouve fermement dans son guidage.

#### **REMARQUE:**

Vous ne pourrez fermer le couvercle du compartiment de poussière que si le sac-filtre à poussière est correctement mis en place.

10. Refermez le couvercle du compartiment à poussière. Vous entendrez un "clic" lorsqu'il s'emboîte.

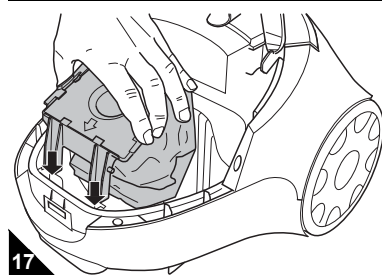
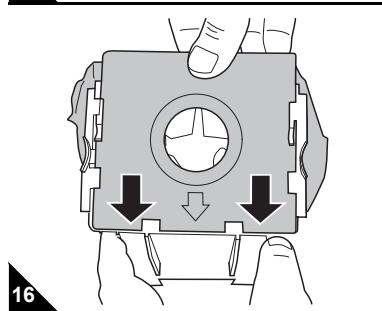
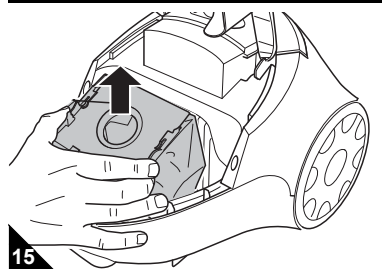





## 3 Entretien



### 3.1 Vue d'ensemble des filtres

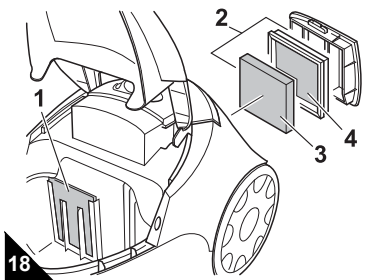

Les filtres peuvent se salir après un certain temps et doivent pour cette raison être régulièrement contrôlés :

**Les filtres suivants sont installés :**

■ **Filter de protection du moteur (ill. 18/1)**

Il empêche les particules grossières d'endommager le moteur lorsque le sac-filtre à poussière est défectueux.  
- Remplacement : après le 5ème changement de sac-filtre à poussière, au plus tard tous les six mois (▷ Chapitre 3.3, „Nettoyage du filtre de protection du moteur”).

■ **Unité de filtre de sortie d'air (ill. 18/2) se composant de**

- Élément de filtre en mousse (ill. 18/3) et
- Support de filtre avec non-tissé cousu (ill. 18/4)

L'unité filtre de sortie d'air filtre les plus fines particules présentes dans l'air rejeté.

- Remplacement : tous les six mois (▷ Chapitre 3.2, „Nettoyage de l'unité de filtre de sortie d'air”).

### 3.2 Nettoyage de l'unité de filtre de sortie d'air

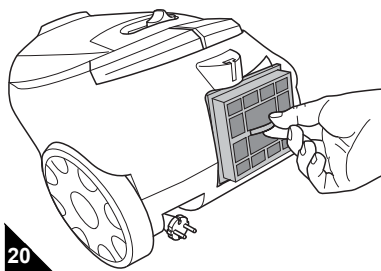
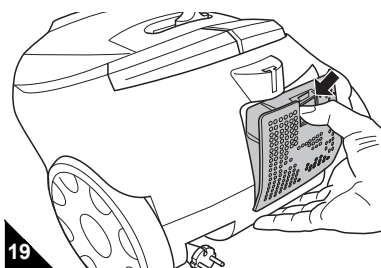

1. Éteignez l'appareil et débranchez-le, ▷ Chapitre 2.3, „Arrêt de l'appareil”.
2. Appuyez sur le déverrouillage du couvercle du filtre de sortie d'air et ouvrez ce dernier (ill. 19).
3. Retirez l'unité de filtre de sortie d'air de sa console au moyen de la languette prévue à cet effet (ill. 20).
4. Maintenez l'unité de filtre de sortie d'air bien au fond d'une poubelle.
5. Retirez l'élément de filtre en mousse du support de filtre.
6. Rincez à fond et à la main les deux éléments de filtre avec de l'eau claire et froide.

**⚠ ATTENTION:**

Les éléments de filtre de l'unité de filtre de sortie d'air sont lavables, mais ne peuvent cependant pas être lavés dans une machine de rinçage ou une machine à laver. N'utilisez en outre aucun produit de nettoyage pour les nettoyer. Faites ensuite sécher les éléments de filtre (environ 24 heures à température ambiante). Remettez-les en place uniquement une fois qu'ils sont complètement secs.

7. Si un des éléments de filtre était endommagé ou déformé, remplacez-le par un nouvel élément (▷ Chapitre 3.4, „Liste des accessoires et des pièces de rechange”).
8. Insérez à nouveau le nouvel élément / l'élément nettoyé du filtre de sortie d'air dans le support de filtre.
9. Remettez maintenant le filtre de sortie d'air fraîchement nettoyé/neuf dans sa console (ill. 20). La languette permettant de retirer le support du filtre doit à cet effet pointer vers l'extérieur de l'appareil.
10. Accrochez d'abord le couvercle du filtre de sortie d'air en bas puis pressez ensuite sur le haut ce celui-ci jusqu'à ce qu'il se mette bien en place (ill. 19).

### 3.3 Nettoyage du filtre de protection du moteur

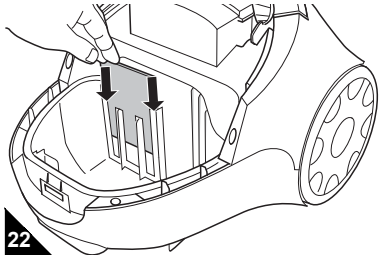
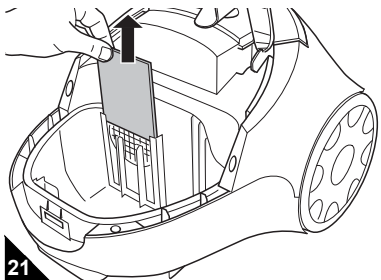

1. Arrêtez l'appareil et retirez le support du sac à poussière avec le sac-filtre à poussière, ▷ Chapitre 2.5, „Remplacement du sac-filtre à poussière”, étapes 1–4.
2. Soulevez le bac à poussière vers le haut pour le sortir de son guide (ill. 21).
3. Rincez à fond et à la main le filtre de protection du moteur avec de l'eau claire et froide.

**⚠ ATTENTION:**

Le filtre est lavable mais ne peut cependant pas être lavé dans une machine de rinçage ou une machine à laver. N'utilisez en outre aucun produit de nettoyage pour les nettoyer. Faites ensuite sécher le filtre de protection du moteur (durant environ 24 heures à température ambiante). Remettez-le en place uniquement une fois qu'il est bien sec.

4. Si le filtre de protection du moteur filtre était endommagé ou déformé, remplacez-le par un nouvel élément (▷ Chapitre 3.4, „Liste des accessoires et des pièces de rechange”).
5. Insérez à nouveau le filtre de protection du moteur dans les guides prévus à cet effet (ill. 22/flèches).
6. Placez le support du sac à poussière avec le sac-filtre à poussière, puis fermez le couvercle du compartiment à poussière. Vous entendrez un "clac" lorsqu'il s'emboîte.

### 3.4 Liste des accessoires et des pièces de rechange

| No. d'art. | Description  |
|------------|--|
| 7010022    | Set comprenant 5 sacs-filtre à poussière et un filtre de protection du moteur                                      |
| 7011002    | 1 unité de filtre de sortie d'air (y compris un élément de filtre (Ill. 18/3) et un support de filtre (Ill. 18/4)) |
| M203       | 1 brosse pour parquets   |
| M209       | 1 turbobrosse  |

### 3.5 Fournisseurs

- Adresse de contact pour passer commande ▷ Page 40, „International Service”.
- Vous trouverez d'autres information sous <http://www.dirtdevil.de>

### 3.6 Recommandation d'achat



Nous vous recommandons d'acheter par la suite : Swirl® Y05 sac-filtre à poussière avec MicroPor® Filtration

**REMARQUE:**

Mettez le sac selon la direction "C".

Swirl®, MicroPor® et "Y05" sont des marques déposées d'une entreprise du groupe Melitta et sont utilisées avec l'accord de ce dernier.



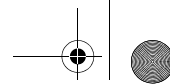

## 4 Élimination des anomalies



### 4.1 Avant d'envoyer l'appareil

Avant de prendre contact avec un commerçant agréé Royal, le service après-vente Royal ou un commerce spécialisé, veuillez vérifier, en vous aidant du tableau ci-dessous, si vous ne pouvez pas remédier vous-même à l'anomalie.



#### AVERTISSEMENT:

Risque de blessures ! N'utilisez jamais un appareil défectueux ! Avant de chercher la cause de l'anomalie, arrêtez l'appareil et débranchez-le, > Chapitre 2.3, „Arrêt de l'appareil“.

| Problèmes   | Causes possibles  | Solutions proposées  |
|---|---|--|
| Impossibilité de mettre en marche l'appareil.                                       | La fiche n'est pas branchée.  | Branchez la fiche dans une prise, puis mettez l'appareil en marche, > Chapitre 2.2, „Utilisation de l'aspirateur“.   |
|   | Il n'y pas de courant à la prise.   | Essayez de brancher l'aspirateur à une autre prise dont vous êtes sûr qu'elle fonctionne.  |
|   | Le cordon d'alimentation est endommagé.   | Faites remplacer le cordon d'alimentation par le service après-vente de Royal Appliance, adresse > Page 40, „International Service“.   |
| L'appareil cesse soudain d'aspirer.   | La protection contre les surchauffes s'est déclenchée (certainement à cause d'une obturation des canaux d'aspiration ou pour une raison semblable). | Éteignez l'appareil et débranchez-le. Éliminez la cause de la surchauffe (par exemple une obturation des canaux d'aspiration ou une raison semblable). Attendez environ 45 minutes. Une fois l'aspirateur refroidi, vous pouvez le remettre en marche. |
| L'indicateur de changement du sac-filtre à poussière est sur "rouge"                | Le sac-filtre à poussière est trop plein.   | Changez le sac-filtre à poussière > Chapitre 2.5, „Remplacement du sac-filtre à poussière“.  |
|   | Le suceur, le manche télescopique ou le flexible sont bouchés.  | Débouchez-les. Si nécessaire, utilisez à cet effet un long morceau de bois (par ex. un manche à balai).  |
|   | Un filtre est sale.   | Nettoyez le filtre correspondant, > Chapitre 3.2, „Nettoyage de l'unité de filtre de sortie d'air“ respectivement > Chapitre 3.3, „Nettoyage du filtre de protection du moteur“.   |
| Le résultat de l'aspiration n'est pas satisfaisant malgré un fonctionnement correct | Le variateur mécanique de puissance (ill. 1/5) est ouvert.  | Refermez le variateur mécanique de puissance (ill. 1/5).   |
|   | Le sac-filtre à poussière est trop plein.   | Changez le sac-filtre à poussière > Chapitre 2.5, „Remplacement du sac-filtre à poussière“.  |
|   | Le suceur, le manche télescopique ou le flexible sont bouchés.  | Débouchez-les. Si nécessaire, utilisez à cet effet un long morceau de bois (par ex. un manche à balai).  |
|   | Un filtre est sale.   | Nettoyez le filtre correspondant, > Chapitre 3.2, „Nettoyage de l'unité de filtre de sortie d'air“ respectivement > Chapitre 3.3, „Nettoyage du filtre de protection du moteur“.   |
| L'appareil est très bruyant   | Un élément aspiré entrave la circulation de l'air.  | Retirez cet élément. Si nécessaire, utilisez à cet effet un long morceau de bois (par ex. un manche à balai).  |

#### REMARQUE:

Prenez contact avec le service à la clientèle Royal (> Page 40, „International Service“) si vous ne pouvez pas remédier vous-même à l'anomalie au moyen de ce tableau.

### 4.2 Élimination



Les filtres sont conçus avec des matériaux écologiques et peuvent être mis à la poubelle. À la fin du cycle de vie de ce produit, en particulier lorsque des dysfonctionnements apparaissent, rendez l'appareil inutilisable en le débranchant et en coupant le cordon d'alimentation. Éliminez l'appareil en tenant compte des réglementations nationales en vigueur en matière de protection de l'environnement. Les déchets électriques ne doivent pas être jetés avec les déchets domestiques. Pour toute question relative au recyclage des déchets, demandez conseil à votre responsable communal ou à votre revendeur.

### 4.3 Conditions de garantie

**Selon les dispositions légales en la matière, nous assurons une garantie de 24 mois sur votre appareil à compter de la date d'achat.**

Pendant la garantie, nous nous réservons le droit de réparer ou de remplacer gratuitement l'appareil ou un accessoire (les accessoires endommagés n'impliquent pas forcément le remplacement de l'appareil) afin de remédier à tout défaut lié au matériel ou à la fabrication. Tout dommage résultant d'une utilisation non conforme (emploi d'une tension ou d'un type de courant erroné, branchement à une prise non adaptée, destruction de l'appareil, etc.) est exclu de la garantie, de même que l'usure et les défauts liés à l'usage normal de l'appareil et qui n'influencent pas son bon fonctionnement. Dans le cas de l'intervention d'une personne ou d'un service non habilité, ou en cas d'utilisation de pièces détachées ne provenant pas de Royal Appliance, les droits de garantie deviennent caducs. Les pièces sujettes à usure sont exclues de la garantie et leur remplacement est payant ! La garantie s'applique uniquement lorsque la date d'achat, complétée par le tampon du revendeur et par sa signature, figurent sur le bon de garantie et que celui-ci ou une copie de la facture d'achat ont été joints à l'appareil qui a été envoyé. Les prestations de garantie n'impliquent en aucune façon le prolongement de la durée de garantie ou un droit à une nouvelle garantie !

### 4.4 En cas de recours à la garantie

Expédiez l'appareil sans sac-filtre à poussière et en décrivant brièvement et en lettres majuscules la façon dont s'est produite l'anomalie. Envoyez le tout par courrier recommandé avec la mention "Zur Garantie" ("Appareil sous garantie"). N'oubliez pas d'y joindre le bon de garantie ou une copie de la facture et envoyez le tout à l'adresse figurant au dos de ce mode d'emploi (> Page 40, „International Service“).

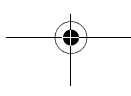



## 1 Overzicht en veiligheid



### Hartelijk dank!

Wij danken u voor de aankoop van de POPSTER en voor het in ons gestelde vertrouwen.

### Overzicht (Afb. 1):

- 1 a: Ontgrendeling voor het deksel van de stofzakruimte;  
b: Handvat om de POPSTER te dragen
- 2 Ontgrendelingstoetsen voor de zuigslang
- 3 Display vervanging v.d. stoffilterzak
- 4 Telescoopbuisarrètering
- 5 Hulpluchtregelaar
- 6 Zuigvermogenregelaar
- 7 Aan/Uit-schakelaar
- 8 Kabeloproltoets
- 9 Ontgrendeling v.d. afdekking v. h. uitblaasfilter
- 10 Omschakelaar „Tapijt/Harde vloer“

### Afb. 2:

- 1 Motorbeveiligingsfilter
- 2 Uitblaasfiltereenheid bestaande uit:
- 3 Schuimrubber-filterelement
- 4 Filterhouder met ingenaaid vlies

### Afb. 3:

- 1 Papieren stoffilterzak met houder (in het apparaat)
- 2 Een extra papieren stoffilterzak (in de doos)
- 3 Bedieningshandleiding

### Afb. 4:

- 1 Houder voor toebehoren
- 2 Kussenmondstuk
- 3 2in1-combimondstuk als voegenmondstuk
- 4 2in1-combimondstuk als meubelborstel

### Afb. 5:

\* optioneel toebehoren:

- 1 \*Parketborstel (M203):  
voor het zuigen van gevoelige oppervlakken. (bijv. laminaat, parket)
- 2 \*Turboborstel (M209):  
Voor de dieptereiniging van tapijten m.b.v. de roterende borstelkop

### Technische gegevens

|                    |  |
|--------------------|--|
| Type apparaat      | : stofzuiger                                 |
| Model              | : <b>POPSTER</b><br><b>M7012</b> (-0/.../-9) |
| Spanning           | : 220 – 240 V~,<br>50/60 Hz                  |
| Vermogen           | : 1.400 W nom –<br>2.000 W max               |
| Stofzakvolume      | : max. benutbaar<br>vulvolume 1,5 liter      |
| Stroomkabel lengte | : ca. 5 m                                    |
| Gewicht            | : ca. 4,5 kg                                 |



Technische en designwijzigingen in verband met voortdurende productverbeteringen voorbehouden. © Royal Appliance International GmbH

### 1.1 m.b.t. deze handleiding

Lees deze bedieningshandleiding volledig door voordat u het apparaat gaat gebruiken. Berg de handleiding goed op. Indien u het apparaat aan iemand anders geeft, geef dan ook de bedieningshandleiding mee.

Belangrijke instructies voor uw veiligheid zijn speciaal gekenmerkt. Neem deze instructies absoluut in acht om ongevallen en schade aan het apparaat te vermijden:



#### WAARSCHUWING:

Waarschuwt voor gevaren voor uw gezondheid en wijst op mogelijk verwondingsrisico.



#### OPGELET:

Wijst op mogelijke gevaren voor het apparaat of andere voorwerpen.

#### AANWIJZING:

Benadrukt tips en informatie.

**Het niet in acht nemen van deze handleiding kan zwaar letsel of schade aan het apparaat tot gevolg hebben.**

Wij zijn niet aansprakelijk voor schade als gevolg van niet-inachtname van deze bedieningshandleiding.

### 1.2 m.b.t. kinderen

■ Dit apparaat is er niet voor bestemd, om door personen (ook kinderen) met een beperkt fysiek, sensorisch of mentaal vermogen of met een gebrek aan ervaring en/of gebrek aan kennis gebruikt te worden, tenzij ze onder toezicht staan van een persoon die voor hun veiligheid verantwoordelijk is of van deze persoon aanwijzingen hebben gekregen, hoe dit apparaat gebruikt moet worden. Kinderen moeten onder toezicht staan, om ervoor te zorgen dat ze niet met het apparaat spelen. Bewaar het apparaat daarom ontoegankelijk voor deze personen.

■ Verpakkingsmaterialen mogen niet worden gebruikt om ermee te spelen. Ze kunnen verstikkingsgevaar opleveren.

### 1.3 m.b.t. doelmatig gebruik

■ De stofzuiger is alleen bedoeld voor huishoudelijk gebruik. Hij is niet geschikt voor industrieel gebruik.

■ Gebruik de stofzuiger uitsluitend voor het reinigen van droge, normaal vervuilde vloeren, tapijten en gordijnen.

**Elke andere vorm van gebruik geldt als niet conform de voorschriften en is niet toegestaan.**

**Verboden is met name:**

■ Het zuigen van:

- lichaamsdelen en dieren. Ze kunnen in de buis worden getrokken en verwond raken.
- kledingstukken die nog gedragen worden. Deze kunnen worden opgezogen en zo verwondingen veroorzaken.
- water en andere vloeistoffen, met name vochtige tapijtreinigingsmiddelen. Vocht in het apparaat kan kortsluiting veroorzaken.
- tonerstof (voor laserprinters, kopieermachines enz.). Dit kan brand- en explosiegevaar tot gevolg hebben.
- gloeiende as, brandende sigaretten of lucifers; Er kan brand ontstaan.
- scherpe voorwerpen, zoals glassplinters, spijkers enz. Deze kunnen het apparaat eventueel beschadigen.
- bouwpuin, gips, cement, fijn boorstof, make-uppoeder, enz. Hierdoor kan het apparaat eventueel beschadigd raken.

■ Het gebruik in de buurt van explosieve of licht ontvlambare stoffen. Brand- en explosiegevaar!

■ Het gebruik in de open lucht. Regen en vuil zouden het apparaat onherstelbaar kunnen beschadigen.

■ Voorwerpen in de openingen van het apparaat steken. Er bestaat verwondingsgevaar.

■ Het apparaat zelfstandig om te bouwen of te repareren. Er bestaat verwondingsgevaar.

### 1.4 m.b.t. de stroomvoeding

■ Het apparaat werkt op elektrische stroom, waarbij in principe altijd het gevaar van een elektrische schok bestaat. Houd daarom speciaal rekening met het volgende:

- Raak de stekker nooit aan met natte handen.
- Trek altijd aan de stekker zelf als u deze uit het stopcontact wilt trekken. Trek nooit aan de stroomkabel, omdat deze dan kan scheuren.
- Zorg ervoor dat de stroomkabel niet knikt, nergens klem komt te zitten, er niet overheen wordt gereden en dat deze niet met hittebronnen in aanraking komt.
- Gebruik alleen verlengkabels die geschikt zijn voor het vermogen van het apparaat.
- Dompel het apparaat nooit in water of andere vloeistoffen en bescherm het tegen regen en vocht;
- Gebruik het apparaat alleen als de op het typeplaatje aangegeven elektrische spanning dezelfde is als die van uw stopcontact. De verkeerde spanning kan het apparaat beschadigen.

### 1.5 bij een defect apparaat

■ Gebruik dit apparaat nooit als het defect is of als de stroomkabel defect is. Als de aansluitkabel van dit apparaat wordt beschadigd, moet deze, om risico te voorkomen, door de fabrikant of de klantenservice van de fabrikant of door iemand met dezelfde competentie worden vervangen.

■ Geef een defect apparaat voor reparatie aan een vakhandelaar of de Royal Appliance klantenservice. Adres > pagina 40, „International Service“.

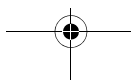
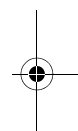



## 2 Bediening

**Royal**

### 2.1 Uitpakken en in elkaar zetten

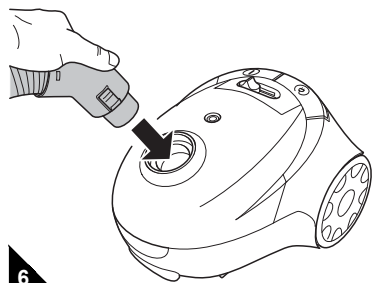

6

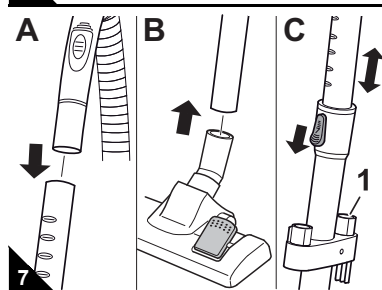

7

1. Pak het apparaat en de toebehoren uit.
2. Controleer de inhoud op intactheid en volledigheid (afb. 1-5).

**AANWIJZING:**

Als u transportschade constateert, wend u dan onmiddellijk tot uw handelaar.

**⚠ OPGELET:**

Transporteer/verzend het apparaat steeds in de originele verpakking, zodat het niet beschadigd raakt. Bewaar daarom de originele verpakking. Gooi het niet meer benodigde verpakkingsmateriaal daarentegen weg zoals voorgeschreven.

**⚠ WAARSCHUWING:**

Verwondingsgevaar! Laat de stekker uit het stopcontact als u de stofzuiger in elkaar zet. Anders kan het apparaat opstarten en kunnen er lichaamsdelen, haren of kledingstukken naar binnen gezogen worden.

3. Steek het uiteinde van de zuigslang zoals afgebeeld in de adapteropening, totdat de vergrendeling hoor- en voelbaar vastklikt (afb. 6).
4. Steek de handgreep in het bovenste uiteinde van de telescoopbuis (afb. 7/A).
5. Steek het gewenste mondstuk op de telescoopbuis (afb. 7/B).
6. Stel de lengte van de telescoopbuis in. Druk hiervoor de telescoopbuisarrêtering naar beneden (afb. 7/C). Trek de telescoopbuis dan op de gewenste lengte. Om te vergrendelen laat u de telescoopbuisarrêtering terwijl u trekt los. U hoort een duidelijk klikgeluid.
7. Berg eventueel niet meer benodigd toebehoren zoals afgebeeld op in de toebehorenhouder (afb. 7/C1). Uw stofzuiger is nu klaar voor gebruik.

### 2.2 Stofzuigen

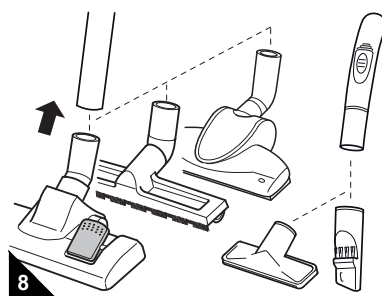

8

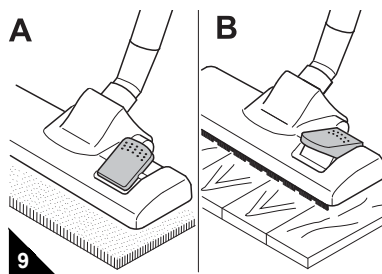

9

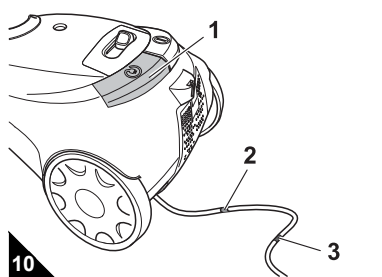

10

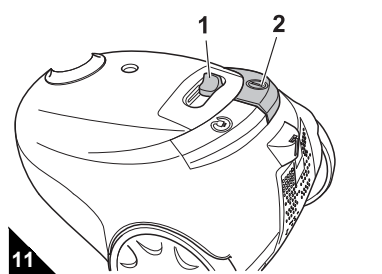

11

**⚠ WAARSCHUWING:**

Verwondingsgevaar! Een beschadigd apparaat mag niet worden gebruikt. Controleer de stofzuiger en de stroomkabel telkens voor gebruik.

**⚠ WAARSCHUWING:**

Verwondingsgevaar! Let er vooral bij het zuigen van trappen op dat u zich steeds boven het apparaat bevindt.

**⚠ OPGELET:**

Gebruik de stofzuiger alleen als alle filters intact, droog en correct geplaatst zijn. Controleer of er geen openingen verstopt zijn. Anders kan de stofzuiger beschadigd raken.

**AANWIJZING:**

Uw stofzuiger heeft een oververhittingsbeveiliging. Hij schakelt bij oververhitting automatisch uit. Als dit het geval is, schakel de stofzuiger dan uit en trek de stekker eruit. Verwijder de oorzaak van de oververhitting. Wacht ca. 45 minuten. De afgekoelde stofzuiger kunt u nu weer inschakelen.

1. Bevestig het gewenste mondstuk (afb. 8).

**⚠ OPGELET:**

Neem de betreffende aanbevelingen van de fabrikant van de vloerbedekking in acht en controleer of het betreffende mondstuk geschikt is voor de afzonderlijke vloerbedekking.

2. Als u het vloermondstuk gebruikt, stel de omschakelaar „Tapijt/Harde vloer“ dan afhankelijk van de vloerbedekking in:
  - **tapijt (afb. 9/A):** voor hoog- en laagpolig tapijt, lopers, enz.
  - **Harde vloer (afb. 9/B):** voor laminaat, tegels, PVC enz.
3. trek de stroomkabel uit de stofzuiger tot aan de gele streep (afb. 10/3).

**⚠ WAARSCHUWING:**

Gevaar voor een elektrische schok! Als de rode markering (afb. 10/2) zichtbaar is, trek de kabel dan weer in met behulp van de kabelproltoets (afb. 10/1) tot aan de gele markering (afb. 10/3). Anders kan de kabel beschadigd raken.

4. Steek de stekker in een stopcontact met randaarde.
5. Schakel de stofzuiger in met de Aan-/Uit-schakelaar (afb. 11/2).
6. Stel de regelaar van het zuigvermogen (afb. 11/1) afhankelijk van de te zuigen ondergrond in.
7. Trek de stofzuiger tijdens het zuigen als een slee achter u aan.

**AANWIJZING:**

Met de hulpluchtregeelaar (afb. 1/5) kunt u het zuigvermogen snel verlagen als er minder zuigkracht moet zijn, bijv. om opgezogen voorwerpen er weer uit te krijgen.





## 2 Bedienung

### 2.3 Uitschakelen

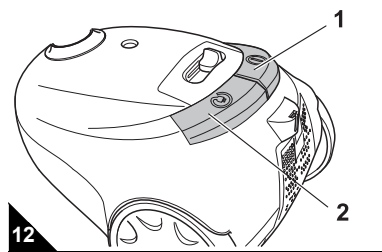

- Schakel de stofzuiger uit met de Aan-/Uit-schakelaar (afb. 12/1) en trek de stekker uit het stopcontact.
- Houd de stekker in uw hand.

#### ⚠ WAARSCHUWING:

Verwondingsgevaar! Bij het ongecontroleerd intrekken van de stroomkabel kan deze rondzwiepen en een struikelgevaar vormen of voorwerpen omver gooien. Houd daarom bij het intrekken van de stroomkabel de stekker in uw hand.

- Druk op de kabelproltoets (afb. 12/2) om de stroomkabel in te trekken.

### 2.4 Transporteren en opbergen

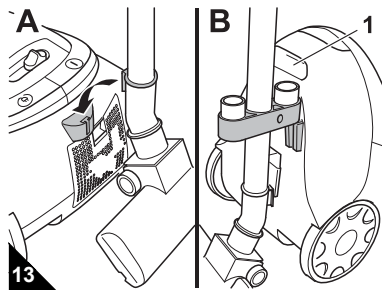

- Om de stofzuiger te **transporteren** kunt u hem aan de draaggreep (afb. 13/B1) dragen.
- Bij **werkpauzes** kunt u de parkeerhaak in de parkeerhouder hangen (afb. 13/A).
- Om de stofzuiger **op te bergen** kunt u de opberghaak in de opberghouder hangen (afb. 13/B).
- Het is raadzaam om van tevoren de telescoopbuis ineen te schuiven ▷ *hoofdstuk 2.1, „Uitpakken en in elkaar zetten“*, stap 4.

#### ⚠ OPGELET:

Zet het apparaat nooit direct naast warmtebronnen neer (bijv. verwarming, kachel). Vermijd direct zonlicht. De hitte kan het apparaat beschadigen.

- Als u de stofzuiger langer wilt **opbergen**, verwijder de stoffilterzak dan ▷ *hoofdstuk 2.5, „Stoffilterzak vervangen“* en gooi de zak weg zoals voorgeschreven. Berg het apparaat dan altijd koel en droog en op een voor kinderen ontoegankelijke plaats op.

### 2.5 Stoffilterzak vervangen

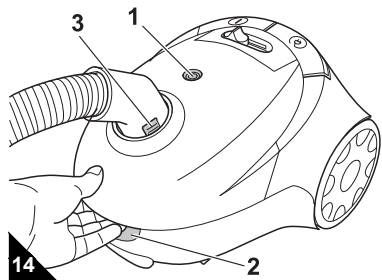

#### ⚠ OPGELET:

Voordat u de stoffilterzak vervangt, schakelt u het apparaat uit. Zo voorkomt u dat stof het apparaat beschadigt.

- Vervang de stoffilterzak, als het display voor de vervanging van de stoffilterzak (afb. 14/1) op „rood“ staat, als u het apparaat voor langere tijd opbergt of als u het wilt doorsturen.
- Vervang de stoffilterzak om hygiënische redenen bovendien uiterlijk elke 3 maanden.

- Schakel het apparaat uit en trek de stekker uit het stopcontact, ▷ *hoofdstuk 2.3, „Uitschakelen“*.
- Open het deksel van de stofzakruimte door op de ontgrendelingstoets te drukken (afb. 14/2) en het deksel vervolgens open te klappen.
- Klap het deksel van de stofzakruimte open tot het voelbaar vastklikt en vanzelf open blijft.

#### AANWIJZING:

Als het deksel van de stofzakruimte niet vanzelf open blijft, is het raadzaam om van tevoren de zuigslang te verwijderen. Druk hiervoor op de twee ontgrendelingstoetsen (afb. 14/3) en trek de zuigslang uit de opname.

- Trek de stofzakhouder met stoffilterzak zoals afgebeeld (afb. 15) naar boven toe uit de stofzuiger

#### AANWIJZING:

Ga bij het verwijderen van de stoffilterzak voorzichtig te werk, zodat er geen stof uit de stoffilterzak ontsnapt.

- Trek de volle stoffilterzak naar boven toe uit de stofzakhouder (afb. 16).

#### AANWIJZING:

De inhoud van de stoffilterzak kunt u meegeven met het gewone huisvuil, voor zover deze geen voor huisvuil verboden vuil bevat.

- Schuif de nieuwe stoffilterzak zoals afgebeeld in de stofzakhouder, totdat de zak achter de twee uitstulpingen door exact tegen de rand van de stofzakhouder aan ligt (afb. 16, pijlen).
- Verwijder stofresten die zich eventueel in de stofzakruimte bevinden.
- Controleer bij deze gelegenheid meteen ook het motorbeschermingsfilter. Vervang het filter zonedig, ▷ *hoofdstuk 3.3, „Motorbeschermingsfilter reinigen“*.
- Plaats de stofzakhouder met de nieuwe stoffilterzak weer in de stofzuiger:
  - Plaats de stofzakhouder hiervoor in de twee daartoe voorziene rails (afb. 17/pijlen).
  - Druk de stofzakhouder daarna zo ver naar beneden, totdat deze op de geleiding ligt.

#### AANWIJZING:

Het deksel van de stofzakruimte kan alleen worden gesloten als de stoffilterzak correct erin geplaatst is.

- Sluit het deksel van de stofzakruimte. Het moet hoorbaar vastklikken.

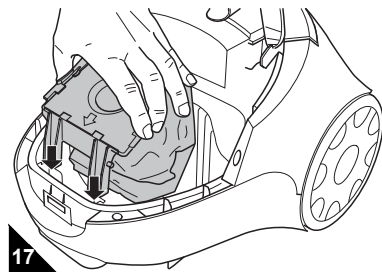
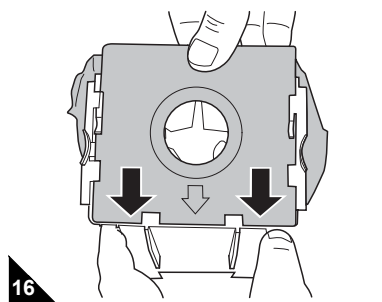
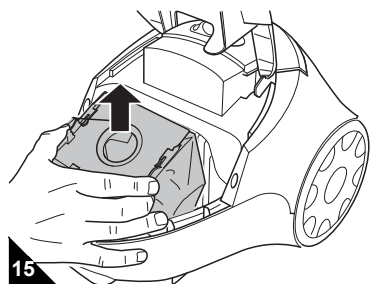



### 3 Onderhoud



#### 3.1 Overzicht van de filters

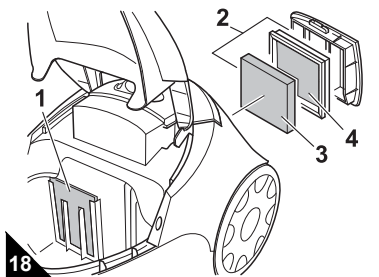

De filters kunnen na verloop van tijd vuil worden en moeten daarom regelmatig worden gecontroleerd:

##### De volgende filters zijn geïnstalleerd:

##### ■ Motorbeschermingsfilter (afb. 18/1)

dit filter voorkomt dat grotere deeltjes de motor onherstelbaar beschadigen als de stoffilterzak defect raakt.

- Vervangen: na elke 5de vervanging van de stoffilterzak, uiterlijk elke 6 maanden (▷ hoofdstuk 3.3, „Motorbeschermingsfilter reinigen“).

##### ■ Uitblaasfiltereenheid (afb. 18/2) bestaande uit

- schuimrubber-filterelement (afb. 18/3) en
- filterhouder met ingenaaid vlies (afb. 18/4)

De uitblaasfiltereenheid filtert zeer fijne deeltjes uit de uitgeblazen lucht.

- Vervangen: elke 6 maanden (▷ hoofdstuk 3.2, „Uitblaasfiltereenheid reinigen“).

#### 3.2 Uitblaasfiltereenheid reinigen

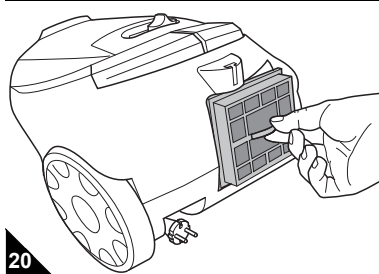
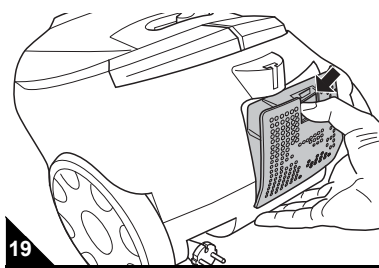

1. Schakel het apparaat uit en trek de stekker uit het stopcontact, ▷ hoofdstuk 2.3, „Uitschakelen“.
2. Druk op de ontgrendeling van de afdekking van het uitblaasfilter en klap de afdekking weg (afb. 19).
3. Neem de uitblaasfiltereenheid aan het daartoe voorziene lipje uit zijn console (afb. 20).
4. Houd de uitblaasfiltereenheid vlak boven een vuinbak.
5. Neem het schuimrubber-filterelement uit de filterhouder.
6. Spoel allebei de filterelementen met de hand grondig uit met helder, koud water.

##### ⚠ OPGELET:

De filterelementen van de uitblaasfiltereenheid zijn wasbaar, maar ongeschikt voor de wasmachine of vaatwasser. Gebruik voor de reiniging geen reinigingsmiddelen. Laat de filterelementen vervolgens drogen (ca. 24 uur bij kamertemperatuur). Plaats ze pas weer terug, als ze helemaal droog zijn.

7. Als een van de filterelementen beschadigd of vervormd is, vervang het dan door een nieuw filter (▷ hoofdstuk 3.4, „Lijst van toebehoren en reserveonderdelen“).
8. Plaats het gereinigde/nieuwe schuimrubber-filterelement in de filterhouder.
9. Plaats de filterhouder met het nieuwe filter nu terug in zijn console (afb. 20). Het lipje van de filterhouder moet hierbij uit het apparaat uitsteken.
10. Haak de afdekking van het uitblaasfilter eerst onderaan vast en druk dan krachtig op de bovenkant, totdat de afdekking voelbaar vastklikt (afb. 19).

#### 3.3 Motorbeschermingsfilter reinigen

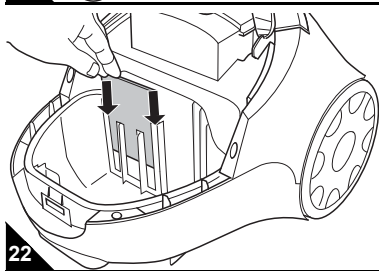
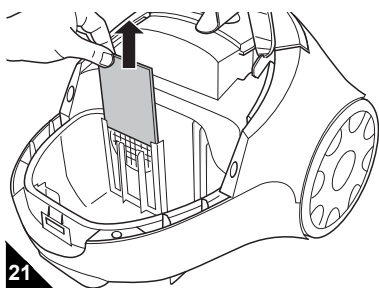

1. Schakel het apparaat uit en verwijder de stoffilterhouder met de stoffilterzak, ▷ hoofdstuk 2.5, „Stoffilterzak vervangen“, stappen 1–4.
2. Trek het motorbeschermingsfilter vervolgens naar boven toe uit de geleiding (afb. 21).
3. Spoel het motorbeschermingsfilter met de hand grondig uit met helder, koud water.

##### ⚠ OPGELET:

Het motorbeschermingsfilter is wasbaar, maar ongeschikt voor de wasmachine of vaatwasser. Gebruik voor de reiniging geen reinigingsmiddelen. Laat het motorbeschermingsfilter vervolgens drogen (ca. 24 uur bij kamertemperatuur). Zet het er pas weer in als het helemaal droog is.

4. Als het motorbeschermingsfilter beschadigd of vervormd is, vervang het filter dan door een nieuw filter (▷ hoofdstuk 3.4, „Lijst van toebehoren en reserveonderdelen“).
5. Schuif het motorbeschermingsfilter weer in de daartoe voorziene geleidingen (afb. 22/pijlen).
6. Zet de stofzakhouder met de stoffilterzak erin en sluit het deksel van de stofzakruimte. Het moet hoorbaar vastklikken.

#### 3.4 Lijst van toebehoren en reserveonderdelen

| Artikelnr. | Beschrijving   |
|------------|--|
| 7010022    | Set met 5 stoffilterzakken en 1 motorbeschermingsfilter  |
| 7011002    | 1 uitblaasfiltereenheid (incl. schuimrubber-filterelement (afb. 18/3) en filterhouder (afb. 18/4)) |
| M203       | 1 parketborstel  |
| M209       | 1 turboborstel   |

#### 3.5 Verkooppunten

- Bestellen ▷ pagina 40, „International Service“
- Verdere informatie vindt u op <http://www.dirtdevil.de>

#### 3.6 Koopadvies



Wij adviseren om Swirl® Y05 stoffilterzakken met MicroPor® filtratie te kopen.

##### AANWIJZING:

Zak in de richting "C" in het apparaat plaatsen.

Swirl®, MicroPor® en "Y05" zijn geregistreerde merken van een onderneming van de Melitta Groep, die met toestemming van deze groep gebruikt worden.



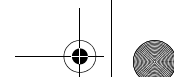

## 4 Problemen verhelpen



### 4.1 Voordat u het apparaat opstuurt

Voordat u contact opneemt met de verantwoordelijke Royal-dealer, Royal-servicepartner of de vakhandel, kunt u aan de hand van de volgende tabel controleren of u het probleem zelf kunt verhelpen.

**WAARSCHUWING:**

Verwondingsgevaar! Gebruik nooit een defect apparaat! Voordat u problemen gaat opsporen schakelt u het apparaat uit en trekt u de netstekker eruit, > hoofdstuk 2.3, „Uitschakelen“.

| Probleem   | Mogelijke oorzaak   | Oplossing  |
|--|---|--|
| Apparaat kan niet aangezet worden.                                   | Stekker zit niet in het stopcontact.  | Steek de stekker in een stopcontact en zet het apparaat aan, > hoofdstuk 2.2, „Stofzuigen“.  |
|  | Stopcontact heeft geen stroom.  | Test de stofzuiger aan een ander stopcontact, waarvan u zeker weet dat er stroom op staat.   |
|  | Stroomkabel is beschadigd.  | Laat de stroomkabel vervangen door de Royal Appliance klantenservice, adres > pagina 40, „International Service“.  |
| Apparaat stopt plotseling met zuigen.                                | De oververhittingsbeveiliging is geactiveerd (eventueel vanwege verstopte aanzuigwegen e.d.). | Schakel het apparaat uit en trek de stekker uit het stopcontact. Verwijder de oorzaak van de oververhitting (bijv. verstopte aanzuigwegen e.d.). Wacht ca. 45 minuten. Het afgekoelde apparaat kunt u nu weer inschakelen. |
| Display vervanging van de stoffilterzak staat op „rood“              | Stoffilterzak is te vol.  | Vervang de stoffilterzak > hoofdstuk 2.5, „Stoffilterzak vervangen“.   |
|  | Mondstuk, telescoopbuis of zuigslang zijn verstopt.   | Verwijder de verstopping. Gebruik hiervoor zonnodig een lange houten stok (bijv. een bezemsteel).  |
|  | Filter is vervuild.   | Reinig het betreffende filter, > hoofdstuk 3.2, „Uitblaasfiltereenheid reinigen“ resp. > hoofdstuk 3.3, „Motorbeschermingsfilter reinigen“.  |
| Zuigresultaat is ondanks een optimale functie niet naar tevredenheid | Hulppluchregelaar (afb. 1/5) is geopend.  | Sluit de hulppluchregelaar (afb. 1/5).   |
|  | Stoffilterzak is te vol.  | Vervang de stoffilterzak > hoofdstuk 2.5, „Stoffilterzak vervangen“.   |
|  | Mondstuk, telescoopbuis of zuigslang zijn verstopt.   | Verwijder de verstopping. Gebruik hiervoor zonnodig een lange houten stok (bijv. een bezemsteel).  |
|  | Filter is vervuild.   | Reinig het betreffende filter, > hoofdstuk 3.2, „Uitblaasfiltereenheid reinigen“ resp. > hoofdstuk 3.3, „Motorbeschermingsfilter reinigen“.  |
| Apparaat maakt buitengewoon hard lawaai.                             | Opgezogen voorwerpen in slang of buis.  | Verwijder de voorwerpen. Gebruik hiervoor zonnodig een lange houten stok (bijv. een bezemsteel).   |

**AANWIJZING:**

Als u het probleem met behulp van deze tabel niet kunt verhelpen, neem dan a.u.b. contact op met de Royal klantenservice (> pagina 40, „International Service“).

### 4.2 Afvalverwijdering



De gebruikte filters zijn vervaardigd uit milieuvriendelijke materialen en kunnen met het huisvuil worden verwijderd. Als de gebruiksduur verstreken is, met name als er functiestoringen optreden, maak dan het afgedankte apparaat onbruikbaar door de netstekker uit het stopcontact te trekken en de stroomkabel door te knippen. Verwijder het apparaat als afval volgens de in uw land geldende milieuvorschriften. Elektrisch afval mag niet samen met huishoudelijk afval worden verwijderd. Wend u voor advies over recycling tot uw gemeentelijke overheid of uw handelaar.

### 4.3 Garantievoorwaarden

**Wij aanvaarden voor het door ons verkochte apparaat de wettelijk voorgeschreven waarborg van 24 maanden vanaf de datum van aankoop.**

Binnen deze waarborgperiode verhelpen wij naar eigen keuze door reparatie of door vervanging van het apparaat of het toebehoren (schade aan toebehoren leidt niet automatisch tot vervanging van het complete apparaat) kosteloos alle gebreken die te herleiden zijn tot materiaal- of productiefouten. Van de garantie uitgesloten is schade die valt te herleiden tot ondeskundig gebruik (bedrijf met verkeerde stroomsoort/-spanning, aansluiting aan niet-geschikte stroombronnen, breuk enz.), normale slijtage en gebreken die de waarde of de deugdelijke bruikbaarheid van het apparaat maar onbeduidend beïnvloeden. Bij ingrepen door een firma die niet door ons is geautoriseerd of bij het gebruik van andere dan de originele Royal Appliance reserveonderdelen vervalt de garantie. Slijtagedelen vallen niet onder de garantie en moeten daarom worden betaald! De waarborg wordt alleen van kracht als de datum van aankoop door een stempel en handtekening van de handelaar op de garantietaal is bevestigd, of als er een kopie van de rekening van het toegestuurde apparaat is bijgevoegd. Garantievergoedingen houden geen verlenging van de garantieperiode in, noch het recht op een nieuwe garantie.

### 4.4 In het geval van garantie

Verstuur het apparaat zonder stoffilterzak en met een korte beschrijving van het defect in blokletters. Voorzie het begeleidende schrijven van de vermelding „Zur Garantie“. Stuur het met de garantietaal of een kopie van de rekening naar het adres dat op de achterkant van deze handleiding aangegeven staat (> pagina 40, „International Service“).



## 1 Vista general y seguridad

### ¡Muchas gracias!

Le agradecemos la compra de la POPSTER y la confianza depositada en nosotros.

#### Vista general (Fig. 1):

- 1 **a:** Desbloqueo para la tapa del compartimiento de polvo;  
**b:** Asa empotrada de transporte
- 2 Teclas de desbloqueo para la manguera de aspiración
- 3 Indicador de cambio de la bolsa filtrante de polvo
- 4 Inmovilizador del tubo telescópico
- 5 Regulador de aire adicional
- 6 Regulador de potencia de aspiración
- 7 Interruptor de conexión / desconexión
- 8 Tecla para enrollar el cable
- 9 Desbloqueo de la cubierta del filtro de evacuación
- 10 Conmutador "Alfombra/Suelo duro"

#### Fig. 2:

- 1 Filtro de protección del motor
- 2 Unidad de filtro de evacuación consistente de:
- 3 Elemento filtrante de gomaespuma
- 4 Soporte de filtro con fieltro cosido

#### Fig. 3:

- 1 Bolsa filtrante de papel con soporte (en el aparato)
- 2 otra bolsa filtrante de papel (en la caja)
- 3 Manual de instrucciones

#### Fig. 4:

- 1 Sujeción de accesorios
- 2 Tobera para tapicerías y cojines
- 3 Tobera combinada 2 en 1 como tobera para ranuras
- 4 Tobera combinada 2 en 1 como pincel para muebles

#### Fig. 5:

\* accesorios opcionales:

- 1 \*Cepillo para parqués (M203): para aspirar superficies delicadas (p. ej. laminados, parqués)
- 2 \*Cepillo turbo (M209): para la limpieza en profundidad de alfombras mediante un cabezal de cepillo giratorio

#### Datos técnicos

|                                    |   |
|------------------------------------|---|
| Tipo de aparato                    | : Aspiradora rodante                      |
| Modelo                             | : <b>POPSTER M7012</b> (-0/.../-9)        |
| Tensión                            | : 220 – 240 V~, 50/60 Hz                  |
| Potencia                           | : 1.400 W nom – 2.000 W máx               |
| Volumen de la bolsa de polvo       | : Volumen útil máx. de llenado 1,5 litros |
| Longitud del cable de alimentación | : aprox. 5 m                              |
| Peso                               | : aprox. 4,5 kg                           |



Nos reservamos el derecho a realizar cambios técnicos y de diseño en el marco de la mejora permanente de nuestros productos.  
© Royal Appliance International GmbH

### 1.1 sobre el manual de instrucciones

Lea este manual de instrucciones por completo antes de utilizar el aparato. Guarde bien las instrucciones. En caso de que ceda este aparato a un tercero, entréguele también el manual de instrucciones.

Las advertencias importantes para su seguridad están marcadas de forma especial. Es imprescindible tener en cuenta estas advertencias para evitar accidentes y daños en el aparato:

#### **AVISO:**

Advierte sobre peligros para su salud y muestra posibles riesgos de lesión.

#### **ATENCIÓN:**

Indica la posibilidad de que el aparato u otros objetos corran peligro.

#### **ADVERTENCIA:**

Destaca consejos e informaciones.

**La inobservancia de este manual puede ser origen de graves lesiones o de daños en el aparato.**

No asumimos ningún tipo de responsabilidad por los daños causados debido a la inobservancia de este manual de instrucciones.

### 1.2 sobre los niños

■ Este aparato no está destinado para ser usado por personas (incluidos niños) con capacidad física, sensorial o mental restringida o con falta de experiencia y/o de conocimientos, a no ser que sean supervisadas por una persona responsable de su seguridad o hayan recibido de ella instrucciones de cómo usar el aparato. Los niños deben ser supervisados para asegurarse de que no jueguen con el aparato. Guarde el aparato de modo inaccesible para este círculo de personas.

■ El material de embalaje no debe ser utilizado para jugar. Existe peligro de asfixia.

### 1.3 sobre el uso conforme

■ La aspiradora rodante está destinada sólo al uso doméstico. No es adecuada para un uso comercial.

■ Emplee la aspiradora rodante exclusivamente para limpiar suelos, alfombras y cortinas secos con un grado normal de suciedad.

**Cualquier otra utilización se considera no conforme y está prohibida.**

**Queda especialmente prohibido lo siguiente:**

■ Aspirar:

- Partes del cuerpo y animales. Pueden ser aspirados y sufrir lesiones.
- Ropa colocada sobre el cuerpo. Puede ser aspirada y causar lesiones.
- Agua y otros líquidos, en especial productos para la limpieza en húmedo de alfombras. La humedad en el interior del aparato puede provocar un cortocircuito.
- Polvo de tóner (para impresoras láser, copiadoras, etc.). Existe el riesgo de incendio y explosión.
- Rescoldos, cigarrillos y cerillas encendidas. Pueden provocar un incendio.
- Objetos puntiagudos como vidrios rotos, clavos, etc. El aparato podría ser dañado.
- Escombros, yeso, cemento, polvo finísimo de taladrar, maquillaje, etc. El aparato podría ser dañado.

■ El uso en las cercanías de materiales explosivos o fácilmente inflamables. Existe riesgo de incendio o explosión.

■ El empleo al aire libre. Existe el peligro de que la lluvia y la suciedad dañen el aparato.

■ La introducción de objetos en las aberturas del aparato. Hay peligro de lesiones.

■ Las modificaciones o reparaciones del aparato por cuenta propia. Hay peligro de lesiones.

### 1.4 sobre la alimentación de corriente

■ El aparato funciona con corriente eléctrica, por tanto existe en general el peligro de una descarga eléctrica. Por esta razón, tenga especialmente en cuenta lo siguiente:

- Jamás toque la clavija con las manos mojadas.
- Quite siempre la clavija de la caja de enchufe tirando directamente de aquélla. Jamás tire directamente del cable eléctrico porque podría romperse.
- Procure que el cable eléctrico no se doble ni quede enganchado y evite que se pase por encima de él o esté en contacto con fuentes de calor.
- Utilice sólo cables de prolongación que estén previstos para el consumo de potencia del aparato.
- Jamás sumerja el aparato en agua u otros líquidos y manténgalo alejado de la lluvia y de la humedad.
- Emplee el aparato únicamente si la tensión eléctrica indicada en la placa de características se corresponde con la tensión de su caja de enchufe. Una tensión equivocada puede dañar el aparato.

### 1.5 En caso de aparato defectuoso

■ Jamás utilice un aparato defectuoso o un aparato con un cable de corriente averiado. Para evitar riesgos, si el cable de conexión de este aparato está dañado, deberá ser reemplazado por el fabricante o por su servicio de asistencia al cliente o por una persona igualmente calificada.

■ Entregue un aparato defectuoso para su reparación a un distribuidor especializado o al Servicio de Atención al Cliente de Royal Appliance. Dirección ▷ *Página 40*, „International Service“.





## 2 Manejo

**Royal**

### 2.1 Desembalar y montar

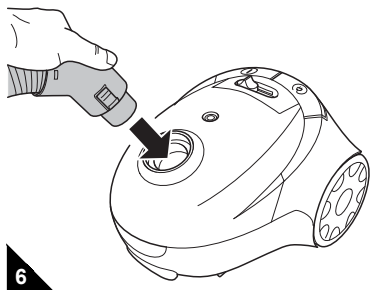

6

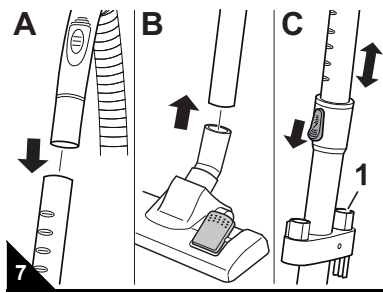

7

1. Saque el aparato junto con los accesorios de su embalaje.
2. Compruebe si el contenido está completo y sin daños (Fig. 1-5).

**ADVERTENCIA:**

En caso de descubrir algún daño debido al transporte, diríjase inmediatamente a su distribuidor.

**⚠ ATENCIÓN:**

Por principio, transporte o envíe el aparato en su embalaje original para que no resulte dañado. Para ello guarde el embalaje original.

Por el contrario, elimine correctamente el material de embalaje que ya no sea necesario.

**⚠ AVISO:**

¡Peligro de lesiones! Monte el aparato sólo cuando la clavija esté desenchufada. De lo contrario el aparato puede arrancar y ser aspirados partes del cuerpo, cabellos o prendas de ropa.

3. Introduzca el extremo de la manguera de aspiración, como se ilustra, en la abertura de alojamiento, hasta que el bloqueo encaje audible y perceptiblemente (fig. 6).
4. Introduzca el asidero en el extremo superior del tubo telescópico (fig. 7/A).
5. Enchufe la tobera deseada en el tubo telescópico (fig. 7/B).
6. Ajuste la longitud del tubo telescópico. Para ello presione el inmovilizador del tubo telescópico hacia abajo (fig. 7/C). A continuación tire el tubo telescópico hasta la longitud deseada. Para bloquear, suelte el inmovilizador del tubo telescópico al tirar de éste. Escuchará claramente como encaja.
7. Coloque los componentes eventualmente no necesarios en la sujeción de accesorios, como se ilustra (fig. 7/C1).

Su aspiradora rodante está ahora lista para ser utilizada.

### 2.2 Aspirar el polvo

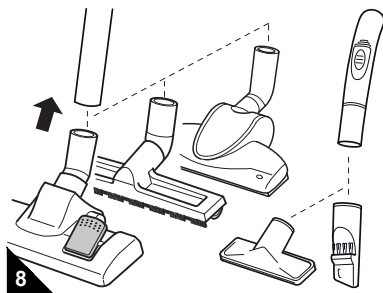

8

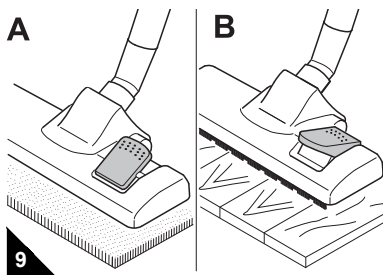

9

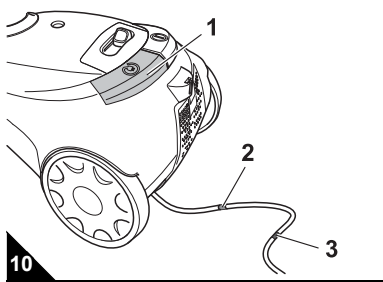

10

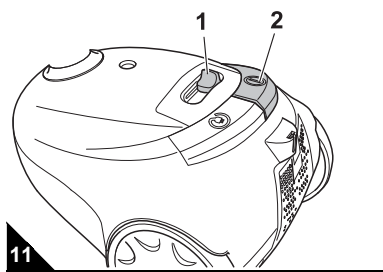

11

**⚠ AVISO:**

¡Peligro de lesiones! Un aparato dañado no debe ser utilizado. Antes de cada uso compruebe la aspiradora rodante y el cable eléctrico.

**⚠ AVISO:**

¡Peligro de lesiones! Preste atención especialmente al aspirar escaleras que usted siempre se encuentre por encima del aparato.

**⚠ ATENCIÓN:**

Emplee la aspiradora rodante únicamente si todos los filtros están intactos, secos y colocados correctamente. Asegúrese de que no esté obstruida ninguna abertura. En caso contrario la aspiradora podría resultar dañada.

**ADVERTENCIA:**

La aspiradora rodante dispone de una protección contra sobrecalentamiento. En caso de sobrecalentamiento se desconecta automáticamente. Si esto ocurriese, desconecte la aspiradora rodante y quite el enchufe. Elimine la causa del sobrecalentamiento. Aguarde aproximadamente 45 minutos. Una vez que la aspiradora rodante se haya enfriado podrá conectarla nuevamente.

1. Enchufe la tobera deseada (fig. 8).

**⚠ ATENCIÓN:**

Observe las recomendaciones de los fabricantes de revestimientos y si la tobera respectiva es adecuada para el correspondiente revestimiento.

2. Al usar la tobera de suelo ajuste el conmutador "Alfombra/Suelo duro" según el tipo de revestimiento:
  - **Alfombra (fig. 9/A):** para alfombras de pelo largo y corto, alfombrillas, etc.
  - **Suelo duro (fig. 9/B):** para laminado, baldosas, PVC, etc.
3. Extraiga el cable de corriente hasta la marca amarilla (fig. 10/3).

**⚠ AVISO:**

¡Peligro de una descarga eléctrica! En caso de que se vea la marca roja (fig. 10/2) vuelva a introducir el cable con la ayuda del pulsador para enrollar el cable (fig. 10/1) hasta la marca amarilla (fig. 10/3). En caso contrario el cable podría resultar dañado.

4. Enchufe la clavija en una caja de enchufe con contacto de protección.
5. Conecte la aspiradora rodante en el interruptor de conexión / desconexión (fig. 11/2).
6. Ajuste el regulador de la potencia de aspiración (fig. 11/1) de acuerdo al suelo a ser aspirado.
7. Para aspirar arrastre la aspiradora rodante a modo de trineo por detrás de usted.

**ADVERTENCIA:**

Con el regulador de aire adicional (fig. 1/5) usted puede reducir rápidamente la potencia de aspiración, en caso de que fuese requerida menor potencia, p. ej. para liberar nuevamente objetos aspirados.



## 2 Manejo

### 2.3 Desconexión

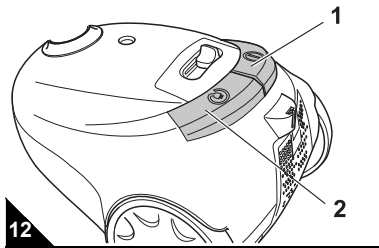

1. Desconecte la aspiradora rodante mediante el interruptor de conexión / desconexión (fig. 12/1) y desenchufe la clavija de la caja de enchufe.
2. Sostenga la clavija en la mano.

#### ⚠ AVISO:

¡Peligro de lesiones! Si el cable eléctrico se enrolla incontroladamente, puede dar bandazos, hacer que se tropiece o producir la caída de objetos. Por ello sostenga la clavija en la mano y condúzcala durante el enrollamiento del cable de corriente.

3. Para recoger el cable de corriente presione el pulsador (fig. 12/2) para enrollarlo.

### 2.4 Transportar y guardar

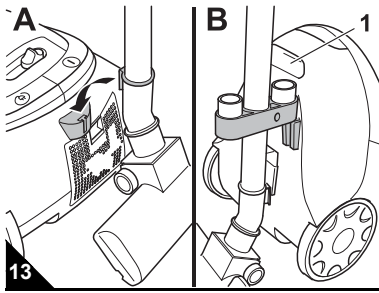

- Para **transportar** el aparato puede usar el asa de transporte (fig. 13/B1).
- Durante las **pausas de trabajo** usted puede colgar el gancho de estacionamiento en el soporte correspondiente (fig. 13/A).
- Para **guardar** usted puede colgar el gancho en la fijación para guardar (fig. 13/B).
- Se recomienda retraer previamente el tubo telescópico ▷ *Capítulo 2.1, "Desembalar y montar", paso 4.*

#### ⚠ ATENCIÓN:

Jamás deje el aparato en la proximidad inmediata de fuentes de calor (p.ej. de la calefacción o del horno). Evite la incidencia directa de rayos solares. El calor puede dañar el aparato.

- Para **guardar el aparato durante un tiempo prolongado** extraiga la bolsa filtrante de polvo ▷ *Capítulo 2.5, "Cambiar la bolsa filtrante de polvo"* y elimínela correctamente. A continuación guarde el aparato siempre en un lugar fresco y seco e inaccesible para los niños.

### 2.5 Cambiar la bolsa filtrante de polvo

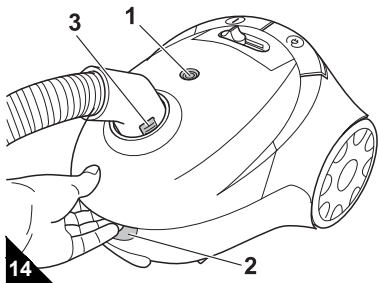

#### ⚠ ATENCIÓN:

Antes de cambiar la bolsa filtrante de polvo, desconecte el aparato. Así evitará que el polvo dañe el aparato.

- Cambie la bolsa filtrante de polvo, cuando el correspondiente indicador de cambio de bolsa (fig. 14/1) esté en „rojo“, antes de un almacenamiento prolongado o de un envío.
- Además, por razones higiénicas, cambie la bolsa filtrante de polvo a más tardar cada 3 meses.

1. Desconecte el aparato y desenchufe la clavija de la caja correspondiente, ▷ *Capítulo 2.3, "Desconexión"*.
2. Abra la tapa del compartimento de polvo pulsando la tecla de desbloqueo (fig. 14/2) y levantándola a continuación.
3. Levante la tapa del compartimento de polvo hasta que haya encastrado perceptiblemente y permanezca abierta por sí misma.

#### ADVERTENCIA:

Si la tapa del compartimento de polvo no quedase abierta por sí misma, se recomienda retirar previamente la manguera de aspiración. Para ello pulse ambas teclas de desbloqueo (fig. 14/3) y extraiga la manguera de aspiración de su alojamiento.

4. Extraiga hacia arriba el soporte de la bolsa de polvo junto con ésta (fig. 15), como se ilustra.

#### ADVERTENCIA:

Al sacar la bolsa filtrante de polvo proceda cuidadosamente para que no haya fuga de polvo de la misma.

5. Extraiga hacia arriba la bolsa filtrante de polvo llena del soporte de la bolsa de polvo (fig. 16).

#### ADVERTENCIA:

El contenido de la bolsa filtrante de polvo puede ser eliminado con la basura doméstica, en tanto no contenga ninguna suciedad que esté prohibida para la eliminación con la basura doméstica mencionada.

6. Deslice la nueva bolsa filtrante de polvo dentro del soporte de la bolsa, como se ilustra, hasta que apoye detrás de los dos resaltes y exactamente en el canto del soporte de la bolsa de polvo (fig. 16, flechas).
7. Elimine los restos de polvo que eventualmente se encuentren en el compartimento de polvo.
8. Aproveche la oportunidad, para controlar asimismo el filtro de protección del motor. Cámbielo en caso necesario, ▷ *Capítulo 3.3, "Limpiar el filtro de protección del motor"*.
9. Vuelva a colocar el soporte de la bolsa de polvo junto con la nueva bolsa filtrante de polvo:
  - Para ello inserte el soporte de la bolsa de polvo dentro de los dos carriles previstos para ello (fig. 17/ flechas).
  - A continuación apriete el soporte de la bolsa de polvo hacia abajo hasta que apoye de manera segura sobre su guía.

#### ADVERTENCIA:

La tapa del compartimento de polvo sólo puede ser cerrada si la bolsa filtrante de polvo está colocada correctamente.

10. Cierre la tapa del compartimento de polvo. Encaja audiblemente.

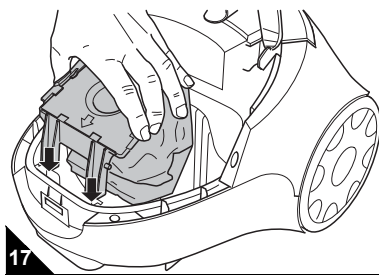
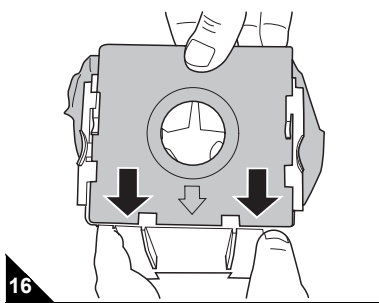
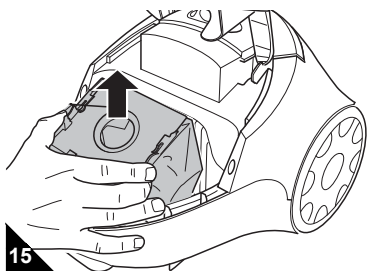



### 3 Mantenimiento

**Royal**

#### 3.1 Resumen sobre los filtros

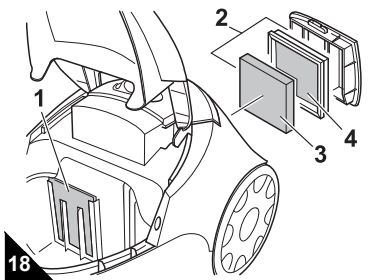

Los filtros se pueden ensuciar después de algún tiempo y por ello deben ser controlados periódicamente: **Están instalados los siguientes filtros:**

■ **Filtro de protección del motor (fig. 18/1)**

Evita que partículas más grandes dañen el motor en caso de que la bolsa filtrante de polvo esté defectuosa.  
- *Reemplazo: después de cada 5° cambio de la bolsa filtrante de polvo, a más tardar cada 6 meses (▷ Capítulo 3.3, "Limpiar el filtro de protección del motor").*

■ **Unidad de filtro de evacuación (fig. 18/2) consistente de:**

- **Elemento filtrante de gomaespuma (fig. 18/3) y**
- **Soporte de filtro con fieltro cosido (fig. 18/4)**

La unidad de filtro de evacuación filtra las partículas más finas del aire evacuado.

- *Reemplazo: cada 6 meses (▷ Capítulo 3.2, "Limpiar la unidad de filtro de evacuación").*

#### 3.2 Limpiar la unidad de filtro de evacuación

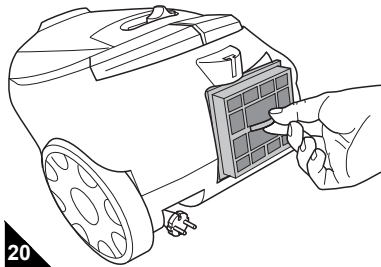
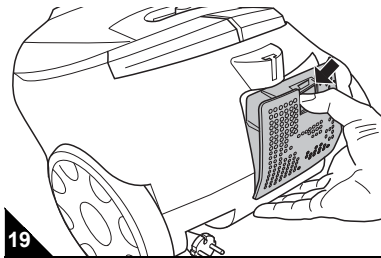

1. Desconecte el aparato y desenchufe la clavija de la caja correspondiente, ▷ *Capítulo 2.3, "Desconexión".*
2. Oprima el desbloqueo de la cubierta del filtro de evacuación y rebátala hacia abajo (fig. 19).
3. Retire la unidad de filtro de evacuación de su consola tirando de la lengüeta prevista para ello (fig. 20).
4. Sostenga la unidad de filtro de evacuación sobre un cubo de basura, aproximándolo lo más posible.
5. Retire el elemento filtrante de gomaespuma del soporte del filtro.
6. Enjuague manualmente a fondo ambos elementos filtrantes con agua clara y fría .

⚠ **ATENCIÓN:**

Los elementos filtrantes de la unidad de filtro de evacuación son lavables pero no son aptos para lavavajillas ni para lavadoras. Además, no use ningún producto de limpieza. A continuación deje secar los elementos filtrantes (aprox. 24 horas a temperatura ambiente). Vuelva a colocarlos de nuevo recién cuando estén totalmente secos.

7. Si uno de los elementos filtrantes estuviese dañado o deformado, reemplácelo por uno nuevo (▷ *Capítulo 3.4, "Lista de accesorios y de piezas de recambio").*
8. Coloque nuevamente el elemento filtrante de gomaespuma limpio/nuevo en el soporte del filtro.
9. Coloque el soporte de filtro con el nuevo elemento filtrante de nuevo en su consola (fig. 20). Al mismo tiempo, la lengüeta de extracción del soporte del filtro debe mostrar hacia fuera del aparato.
10. Primero enganche la cubierta del filtro de evacuación abajo y presione arriba hasta que encaje perceptiblemente (fig. 19).

#### 3.3 Limpiar el filtro de protección del motor

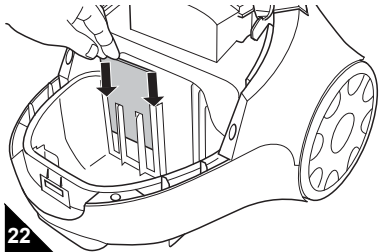
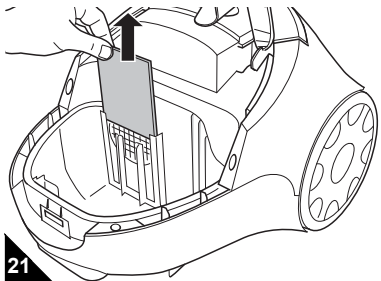

1. Desconecte el aparato y extraiga el soporte de la bolsa de polvo junto con la bolsa misma, ▷ *Capítulo 2.5, "Cambiar la bolsa filtrante de polvo", pasos 1-4.*
2. Extraiga hacia arriba el filtro de protección del motor de su guía (fig. 21).
3. Enjuague manualmente a fondo el filtro de protección del motor con agua clara y fría.

⚠ **ATENCIÓN:**

El filtro de protección del motor es lavable pero no es apto para lavavajillas ni para lavadoras. Además, no use ningún producto de limpieza. A continuación deje secar el filtro de protección del motor (aprox. 24 horas a temperatura ambiente). Introdúzcalo de nuevo recién cuando esté totalmente seco.

4. Si el filtro de protección del motor hubiese sido dañado o deformado, reemplácelo por uno nuevo (▷ *Capítulo 3.4, "Lista de accesorios y de piezas de recambio").*
5. Introduzca de nuevo el filtro de protección del motor en las guías previstas para ello (fig. 22/flechas).
6. Coloque el soporte de la bolsa de polvo con la bolsa correspondiente y cierre la tapa del compartimiento de polvo. Encaja audiblemente.

#### 3.4 Lista de accesorios y de piezas de recambio

| Nº de artículo | Descripción   |
|----------------|---|
| 7010022        | Juego con 5 bolsas filtrantes de polvo y 1 filtro de protección del motor                                   |
| 7011002        | 1 unidad de filtro de evacuación (incl. elemento de gomaespuma (fig. 18/3) y soporte de filtro (fig. 18/4)) |
| M203           | 1 cepillo para parqués  |
| M209           | 1 cepillo turbo   |

#### 3.5 Distribuidores

- Contacto para pedidos ▷ *Página 40, „International Service“.*
- Encontrará otras informaciones bajo <http://www.dirtdevil.de>

#### 3.6 Recomendación de compra



Le recomendamos comprar posteriormente: *bolsas filtrantes de polvo Swirl® Y05 con MicroPor® Filtration*

**ADVERTENCIA:**

Colocar la bolsa en dirección "C"

Swirl®, MicroPor® e "Y05" son marcas registradas de una empresa del grupo Melitta, que son usadas con su autorización.

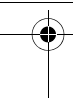

## 4 Solución de problemas



### 4.1 Antes de enviar el aparato

Antes de contactar a su concesionario oficial Royal, al socio de servicio Royal o a su mercado especializado, verifique con la siguiente tabla si usted puede solucionar el problema por sí mismo.

#### AVISO:

¡Peligro de lesiones! ¡Jamás utilice un aparato defectuoso! Antes de ponerse a localizar el problema, desconecte el aparato y desenchufe la clavija, > Capítulo 2.3, "Desconexión".

| Problema   | Posible causa   | Solución  |
|--|---|---|
| El aparato no se deja conectar.  | La clavija no está enchufada.   | Introduzca la clavija en una caja de enchufe y conecte el aparato, > Capítulo 2.2, "Aspirar el polvo".  |
|  | La caja de enchufe no tiene corriente.  | Compruebe el funcionamiento de la aspiradora rodante con otra caja de enchufe de la que esté seguro que conduce corriente.  |
|  | El cable de corriente está dañado.  | Haga reemplazar el cable de corriente por el Servicio de Atención al Cliente de Royal Appliance, dirección > Página 40, "International Service".  |
| El aparato deja súbitamente de aspirar.  | Ha disparado la protección contra sobrecalentamiento (posiblemente debido a tuberías o similares obstruidos). | Desconecte el aparato y desenchufe la clavija. Elimine la causa del sobrecalentamiento (p. ej. conductos o similares obstruidos). Espere aproximadamente 45 minutos. Una vez que el aparato se haya enfriado podrá conectarlo nuevamente. |
| El indicador de cambio de la bolsa filtrante de polvo muestra "Rojo"                     | La bolsa filtrante de polvo está excesivamente llena.   | Cambie la bolsa filtrante de polvo > Capítulo 2.5, "Cambiar la bolsa filtrante de polvo".   |
|  | La tobera, el tubo telescópico o la manguera de aspiración están obstruidos.                                  | Elimine la obstrucción. Si fuese necesario, utilice para ello una vara larga de madera (p.ej. un palo de escoba).   |
|  | El filtro está sucio.   | Limpie el filtro correspondiente, > Capítulo 3.2, "Limpiar la unidad de filtro de evacuación" o bien > Capítulo 3.3, "Limpiar el filtro de protección del motor".   |
| El resultado de la aspiración no es satisfactorio a pesar de un funcionamiento correcto. | El regulador de aire adicional (fig. 1/5) está abierto.   | Cierre el regulador de aire adicional (fig. 1/5).   |
|  | La bolsa filtrante de polvo está excesivamente llena.   | Cambie la bolsa filtrante de polvo > Capítulo 2.5, "Cambiar la bolsa filtrante de polvo".   |
|  | La tobera, el tubo telescópico o la manguera de aspiración están obstruidos.                                  | Elimine la obstrucción. Si fuese necesario, utilice para ello una vara larga de madera (p.ej. un palo de escoba).   |
|  | El filtro está sucio.   | Limpie el filtro correspondiente, > Capítulo 3.2, "Limpiar la unidad de filtro de evacuación" o bien > Capítulo 3.3, "Limpiar el filtro de protección del motor".   |
| El aparato hace más ruido que el habitual  | Partículas aspiradas obstruyen el paso de aire.   | Elimine las partículas. Si fuese necesario, utilice para ello una vara larga de madera (p.ej. un palo de escoba).   |

#### ADVERTENCIA:

Si con la ayuda de esta tabla usted no pudo solucionar el problema, contacte al Servicio de Atención al Cliente de Royal (> Página 40, "International Service").

### 4.2 Eliminación



Los filtros utilizados están fabricados de materiales compatibles con el medio ambiente y pueden ser eliminados con la basura doméstica. Cuando el aparato haya alcanzado el fin de su vida útil, en especial cuando aparezcan problemas de funcionamiento, inutilícelo desenchufando la clavija y cortando el cable eléctrico. Elimine el aparato de acuerdo con las normas medioambientales vigentes en su país. Los residuos eléctricos no deben ser desechados con los residuos domésticos. Diríjase a su ayuntamiento o a su proveedor en caso de dudas sobre el reciclaje.

### 4.3 Condiciones de la garantía

**Para el aparato distribuido por nosotros nos hacemos cargo de la garantía legalmente prescrita de 24 meses a partir de la fecha de compra.**

Durante este plazo de garantía eliminaremos gratuitamente todos los fallos que se deban al material o a defectos de fabricación. Esta eliminación se efectuará a nuestra elección, por la reparación o el cambio del aparato o del accesorio (los daños a piezas de accesorios no conducen automáticamente a un cambio de todo el aparato). Quedan excluidos de la garantía los daños que sean consecuencia de un uso inadecuado (operación del aparato con un tipo de corriente/tensión equivocados, conexión a una fuente de alimentación inadecuada, rotura, etc.), de desgaste normal y las deficiencias que no influyan significativamente sobre el valor o la utilidad del aparato. En caso de que intervengan establecimientos no autorizados por nosotros o se utilicen piezas de recambio que no sean las originales de Royal Appliance se extinguirá la garantía. ¡Las piezas de desgaste no están incluidas en la garantía y por lo tanto no son gratuitas! La prestación de garantía sólo entrará en vigencia si la tarjeta de garantía está provista de la fecha de compra, validada por el sello y la firma del vendedor o si se adjunta una copia de la factura de compra del aparato enviado. ¡Los servicios de garantía no generan una prolongación del período de garantía, ni comienza por ello el derecho a una nueva garantía!

### 4.4 En el caso de garantía

Envíe el aparato sin bolsa filtrante de polvo junto con una breve descripción del fallo en letra de imprenta. Indique en la carta de acompañamiento la observación "Para garantía". Envíelo junto con la tarjeta de garantía o con una copia de la factura de compra a la dirección indicada en el reverso de estas instrucciones (> Página 40, "International Service").

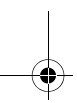

## 1 Vista d'insieme e Sicurezza

### Grazie!

Vi ringraziamo per l'acquisto dello POPSTER e per la fiducia accordataci!

### Vista d'insieme

#### Fig. 1:

- 1 **a:** Sblocco del coperchio del vano sacchetto; **b:** Impugnatura incassata per il trasporto
- 2 Tasti di sblocco del flessibile di aspirazione
- 3 Indicatore di cambio sacchetto del filtro della polvere
- 4 Arresto del tubo telescopico
- 5 Regolatore dell'aria secondario
- 6 Regolatore della potenza di aspirazione
- 7 Interruttore ON/OFF
- 8 Tasto avvolgicavo
- 9 Sblocco del coperchio del filtro dell'aria uscente
- 10 Selettore "tappeti e moquette/pavimenti duri"

#### Fig. 2:

- 1 Filtro di protezione del motore
- 2 Unità filtro dell'aria uscente composta da:
- 3 Elemento filtro in espanso
- 4 Portafiltro con TNT cucito all'interno

#### Fig. 3:

- 1 Sacchetto del filtro della polvere in carta con supporto (nell'apparecchio)
- 2 un ulteriore sacchetto del filtro della polvere in carta (nel cartone)
- 3 Istruzioni per l'uso

#### Fig. 4:

- 1 Portaccessori
- 2 Bocchetta per imbottiture
- 3 Bocchetta combinata 2 in 1 quale bocchetta per fughe
- 4 Bocchetta combinata 2 in 1 quale pennello per mobili

#### Fig. 5:

\* Accessori opzionali:

- 1\* Spazzola per parquet (M203): per aspirare superfici delicate (ad es. laminato, parquet)
- 2\* Spazzola turbo (M209): per la pulizia a fondo di tappeti e moquette mediante testa a spazzola rotante

### Dati tecnici

|                      |  |
|----------------------|--|
| Tipo di apparecchio: | Aspirapolvere                          |
| Modello              | : POPSTER<br>M7012 (-0/.../-9)         |
| Tensione             | : 220 - 240 V~,<br>50/60 Hz            |
| Potenza              | : 1.400 W nom-<br>2.000 W max          |
| Volume del sacchetto | : Capacità max. utilizzabile 1,5 litri |
| Cavo elettrico       | : circa 5 m                            |
| Peso                 | : circa 4,5 kg                         |



Con riserva di modifiche tecniche e costruttive finalizzate al costante perfezionamento del prodotto. © Royal Appliance International GmbH

### 1.1 sulle istruzioni per l'uso

Prima di lavorare con l'apparecchio leggere interamente le presenti istruzioni per l'uso. Conservarle accuratamente. Se l'apparecchio è ceduto a terzi consegnare anche le istruzioni per l'uso.

Le avvertenze importanti ai fini della sicurezza sono contrassegnate in maniera particolare. Per evitare incidenti e danni all'apparecchio è assolutamente necessario osservare queste avvertenze:

#### AVVERTIMENTO:

Avverte di pericoli sanitari e possibili rischi di lesioni.

#### ATTENZIONE:

Segnala possibili pericoli di danni all'apparecchio o ad altri oggetti.

#### INDICAZIONE:

Evidenzia suggerimenti e informazioni utili per l'utente.

**La mancata osservanza delle presenti istruzioni può infatti causare gravi lesioni o danni all'apparecchio.** Non rispondiamo di eventuali danni causati dalla mancata osservanza delle presenti istruzioni per l'uso.

### 1.2 su determinati gruppi di persone

■ Questo apparecchio non è destinato a essere utilizzato da persone (bambini compresi) con limitate capacità fisiche, sensoriali o intellettive o che non dispongano di sufficiente esperienza e/o conoscenze, se non sotto la sorveglianza di una persona responsabile della loro sicurezza o a meno che non abbiano ricevuto da essa istruzioni sul suo utilizzo. I bambini devono essere sorvegliati per accertarsi che non giochino con l'apparecchio. Tra l'altro i bambini non devono né salire né sedersi sull'apparecchio. Conservare l'apparecchio in modo che sia inaccessibile per questa cerchia di persone.

■ I materiali da imballo non devono essere usati per giocare. Sussiste il pericolo di soffocamento.

### 1.3 sull'impiego conforme alla destinazione d'uso

■ L'aspirapolvere può essere usato soltanto in ambito domestico. Non è adatto per l'impiego industriale.

■ L'aspirapolvere deve essere utilizzato esclusivamente per pulire pavimenti, tappeti, moquette e tende asciutti e normalmente sporchi.

**Ogni altro utilizzo è considerato non conforme alla destinazione d'uso e pertanto vietato.**

**In particolare è vietato:**

■ Aspirare:

- Persone, animali, piante, in particolare capelli, dita o altre parti del corpo nonché capi di vestiario indossati. Possono venir risucchiati, causando gravi lesioni.
- Acqua e altri liquidi, in particolare detersivi per la pulizia a umido di tappeti e moquette. L'umidità presente all'interno può infatti causare cortocircuiti.
- Polvere di toner (per stampanti laser, fotocopiatrici, ecc.). Sussiste il pericolo di incendi ed esplosioni.
- Cenere incandescente, sigarette o fiammiferi accesi. Possono causare incendi.
- Oggetti appuntiti, come schegge di vetro, chiodi, ecc. L'apparecchio potrebbe subire dei danni.
- Macerie, gesso, cemento, polveri da trapanazioni, trucchi, ecc. L'apparecchio potrebbe venir danneggiato.

■ L'impiego nei pressi di sostanze esplosive o facilmente infiammabili. Sussiste il pericolo di incendi o esplosioni.

■ L'utilizzo all'aperto. Vi è il pericolo che pioggia e sporco distruggano l'apparecchio.

■ Introdurre oggetti nelle aperture dell'elettrodomestico. Sussiste il pericolo di lesioni.

■ Modifiche o riparazioni autonome dell'elettrodomestico. Sussiste il pericolo di lesioni.

### 1.4 sull'alimentazione elettrica

■ L'apparecchio è azionato a energia elettrica; quindi in linea di principio sussiste il pericolo di prendere la scossa. Pertanto è necessario osservare in particolare quanto segue:

- Non toccare mai la spina a mani bagnate.
- Per staccare la spina dalla presa elettrica, afferrare sempre direttamente la spina e mai il cavo elettrico, in quanto potrebbe strapparsi.
- Assicurarsi che il cavo elettrico non sia piegato o incastrato, non venga calpestato e non entri a contatto con fonti di calore.
- Usare soltanto cavi di prolunga dimensionati per la potenza assorbita dall'elettrodomestico.
- Non immergere mai l'elettrodomestico in acqua o altri liquidi e tenerlo lontano da pioggia e umidità.
- Mettere in funzione l'apparecchio soltanto se la tensione indicata sulla targhetta di omologazione corrisponde a quella della presa elettrica. Tensioni errate possono infatti danneggiare l'apparecchio.

### 1.5 se l'apparecchio è difettoso

■ Non far mai funzionare l'apparecchio se esso o il relativo cavo elettrico sono difettosi. Se la conduttura di allacciamento di questo apparecchio è danneggiata, per prevenire eventuali pericoli, deve essere sostituita dal produttore, dal servizio assistenza o da un tecnico adeguatamente qualificato.

■ Per la riparazione consegnare l'apparecchio difettoso a un rivenditore specializzato o all'assistenza clienti Royal Appliance. Indirizzo ► pagina 40, „International Service“.



## 2 Uso

**Royal**

### 2.1 Disimballo e montaggio

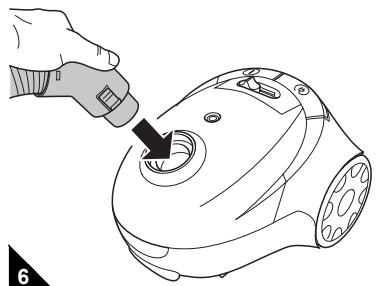

6

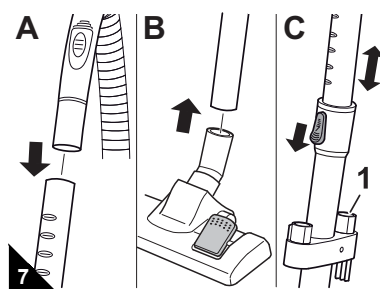

7

1. Sballare l'apparecchio e i relativi accessori.
2. Controllare che il contenuto sia integro e completo (Fig. 1-5).

**INDICAZIONE:**

Se si rilevano danni da trasporto rivolgersi immediatamente al rivenditore competente.

**⚠ ATTENZIONE:**

In linea di principio l'apparecchio deve essere trasportato/spedito nell'imballo originale, in modo che non subisca danni. Pertanto è necessario conservare l'imballo. Smaltire correttamente il materiale da imballo non più necessario.

**⚠ AVVERTIMENTO:**

Pericolo di lesioni! Montare l'apparecchio soltanto con la spina staccata dalla presa elettrica. Altrimenti l'apparecchio può avviarsi e risucchiare parti del corpo, capelli o capi di vestiario.

3. Inserire l'estremità del flessibile di aspirazione nel foro di ricezione come illustrato finché il bloccaggio scatta percettibilmente in posizione (Fig. 6).
4. Introdurre l'impugnatura nell'estremità superiore del tubo telescopico (Fig. 7/A).
5. Applicare la bocchetta desiderata sul tubo telescopico (Fig. 7/B).
6. Regolare la lunghezza del tubo telescopico. Per far ciò premere verso il basso il relativo arresto (Fig. 7/C). Quindi estrarre il tubo telescopico alla lunghezza desiderata. Per effettuare il bloccaggio durante l'estrazione rilasciare l'arresto del tubo telescopico. Si sentirà un clic percettibile.
7. Eventualmente riporre gli accessori non richiesti nel portaccessori (Fig. 7/C1) come raffigurato. L'aspirapolvere è ora pronto a funzionare.

### 2.2 Aspirare

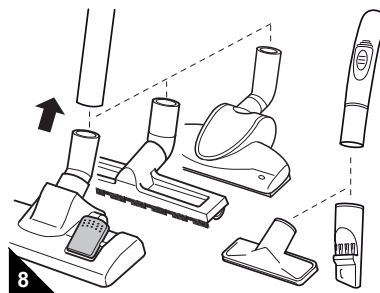

8

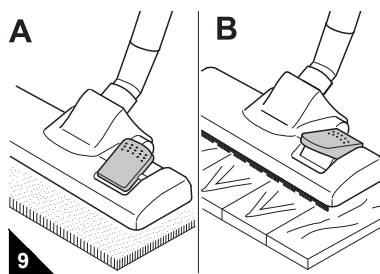

9

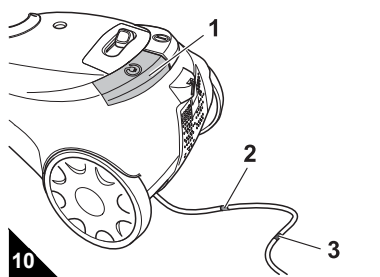

10

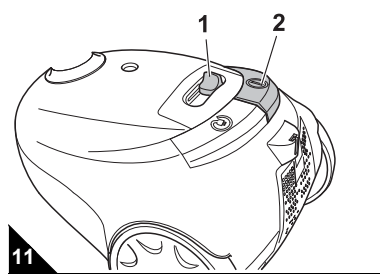

11

**⚠ AVVERTIMENTO:**

Pericolo di lesioni! Non usare mai l'apparecchio se difettoso. Prima di ogni utilizzo verificare sempre l'aspirapolvere e il cavo elettrico.

**⚠ AVVERTIMENTO:**

Pericolo di lesioni! In particolare quando si usa l'aspirapolvere su scale, controllare di trovarsi sempre al di sopra dell'apparecchio.

**⚠ ATTENZIONE:**

Utilizzare l'aspirapolvere soltanto se tutti i filtri sono integri, asciutti e correttamente montati. Assicurarsi che nessuna delle aperture sia ostruita. Altrimenti l'aspirapolvere può subire danni.

**INDICAZIONE:**

L'aspirapolvere è dotato di una protezione contro i surriscaldamenti che disattiva automaticamente l'apparecchio in caso di surriscaldamento. In questo caso spegnere l'aspirapolvere e staccare la spina. Eliminare la causa del surriscaldamento. Attendere circa 45 minuti. L'aspirapolvere raffreddato può, quindi, essere riacceso.

1. Applicare la bocchetta desiderata (Fig. 8).

**⚠ ATTENZIONE:**

Per stabilire se la relativa bocchetta è indicata per il rispettivo rivestimento osservare le raccomandazioni del produttore del rivestimento.

2. Se si utilizza la bocchetta per pavimenti impostare il selettore "tappeti e moquette/pavimenti duri" a seconda del rivestimento del pavimento:
  - **Tappeti e moquette (Fig. 9/A):** per tappeti, moquette e passatoie a pelo lungo/corto, ecc.
  - **Pavimenti duri (Fig. 9/B):** per laminato, piastrelle, PVC ecc.
3. Estrarre il cavo elettrico fino alla marcatura gialla (Fig. 10/3).

**⚠ AVVERTIMENTO:**

Pericolo di scosse elettriche! Se la marchiatura rossa (Fig. 10/2) risulta visibile, riavvolgere il cavo tramite il tasto avvolgicavo (Fig. 10/1) sino alla marchiatura gialla (Fig. 10/3). Altrimenti il cavo può rimanere danneggiato.

4. Inserire la spina in una presa elettrica con contatto di protezione.
5. Accendere l'aspirapolvere mediante l'interruttore ON/OFF (Fig. 11/2).
6. Impostare il regolatore della potenza di aspirazione (Fig. 11/1) a seconda del pavimento da aspirare.
7. Per aspirare trascinare l'aspirapolvere dietro di sé come una slitta.

**INDICAZIONE:**

Con il regolatore dell'aria secondario (Fig. 1/5) è possibile ridurre rapidamente la potenza di aspirazione se è richiesta una potenza di aspirazione inferiore, ad es. per liberare eventuali oggetti risucchiati.

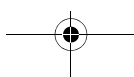



## 2 Uso

**Royal**

### 2.3 Spegnimento

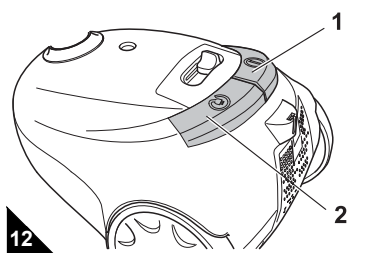

1. Spegner l'aspirapolvere tramite l'interruttore ON/OFF (Fig. 12/1) e staccare la spina dalla presa elettrica.
2. Tenere in mano la spina.

**⚠ AVVERTIMENTO:**

Pericolo di lesioni! Se il cavo elettrico rientra in maniera incontrollata può avvinghiarsi, facendo inciampare o ribaltando oggetti. Pertanto tenere in mano la spina e durante la retrazione accompagnare il cavo elettrico con la mano.

3. Premere il tasto avvolgicavo (Fig. 12/2) per far rientrare il cavo elettrico.

### 2.4 Trasporto e riponimento

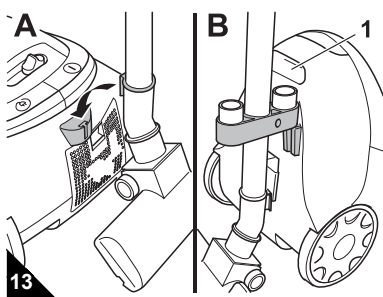

- Per il **trasporto** l'apparecchio può essere trasportato per l'apposito manico da trasporto (Fig. 13/B1).
- Durante le **pause nel lavoro** il gancio da parcheggio può essere inserito nel supporto da parcheggio (Fig. 13/A).
- Per il **riponimento** il gancio riponitore può essere agganciato al supporto riponitore (Fig. 13/B).
- Prima si raccomanda di far rientrare il tubo telescopico ▷ *Capitolo 2.1, "Disimballo e montaggio"*, punto 4.

**⚠ ATTENZIONE:**

Non riporre mai l'apparecchio direttamente accanto a fonti di calore (ad es. riscaldamento, forno). Evitare le radiazioni solari dirette. Il calore può infatti danneggiare l'apparecchio.

- Per **riponimenti** di lunga durata rimuovere il sacchetto del filtro della polvere ▷ *Capitolo 2.5, "Cambio del sacchetto del filtro della polvere"* e smaltirlo correttamente. Conservare sempre l'apparecchio in un luogo fresco, asciutto e fuori dalla portata dei bambini.

### 2.5 Cambio del sacchetto del filtro della polvere

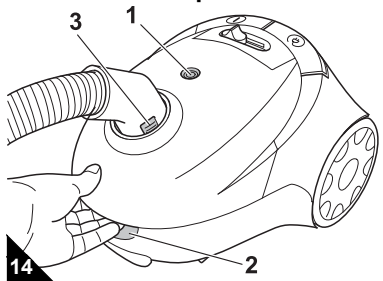
**⚠ ATTENZIONE:**

Prima di sostituire il sacchetto del filtro della polvere, spegnere l'apparecchio. In questo modo si evita che la polvere danneggi l'apparecchio.

- Sostituire il sacchetto del filtro della polvere quando l'indicatore di cambio sacchetto (Fig. 14/1) segnala "rosso", prima di lunghe conservazioni o prima della spedizione.
  - Inoltre, per motivi igienici, il sacchetto del filtro della polvere deve essere sostituito al più tardi ogni 3 mesi.
1. Spegner l'apparecchio e staccarne la spina dalla presa elettrica, ▷ *Capitolo 2.3, "Spegnimento"*.
  2. Aprire il coperchio del vano sacchetto premendo il relativo tasto di sblocco (Fig. 14/2) e quindi sollevandolo.
  3. Sollevare il coperchio del vano sacchetto finché scatta percettibilmente in posizione, restando quindi aperto da solo.

**INDICAZIONE:**

Qualora il coperchio del vano sacchetto non rimanga aperto da solo, per prima cosa si raccomanda di rimuovere il flessibile di aspirazione. Per far ciò premere entrambi i tasti di sblocco (Fig. 14/3) ed estrarre il flessibile di aspirazione dal relativo alloggiamento.

4. Estrarre il portasacchetto unitamente al sacchetto del filtro della polvere come raffigurato (Fig. 15) tirandolo verso l'alto.

**INDICAZIONE:**

Nel rimuovere il sacchetto del filtro della polvere procedere con cautela in modo che la polvere non possa fuoriuscire.

5. Estrarre il sacchetto del filtro della polvere pieno dal portasacchetto (Fig. 16) tirandolo verso l'alto.

**INDICAZIONE:**

Il contenuto del sacchetto del filtro della polvere può essere smaltito tramite i rifiuti domestici, a meno che non comprenda sporco non ammesso nei rifiuti domestici.

6. Spingere il nuovo sacchetto del filtro della polvere nel portasacchetto come raffigurato finché poggia esattamente contro l'angolo del portasacchetto (Fig. 16, freccia).
7. Rimuovere i residui di polvere eventualmente presenti nel vano sacchetto.
8. Con l'occasione controllare anche il filtro di protezione del motore. Se necessario sostituirlo, ▷ *Capitolo 3.3, "Pulizia del filtro di protezione del motore"*.
9. Reinscrivere il portasacchetto assieme al nuovo sacchetto del filtro della polvere:
  - Per far ciò introdurre il portasacchetto nei due appositi binari (Fig. 17/freccia).
  - Quindi premere il portasacchetto verso il basso finché poggia saldamente sulla relativa guida.

**INDICAZIONE:**

Il coperchio del vano sacchetto può essere chiuso soltanto se il sacchetto del filtro della polvere è stato correttamente inserito.

10. Chiudere il coperchio del vano sacchetto. Scatta percettibilmente in posizione.

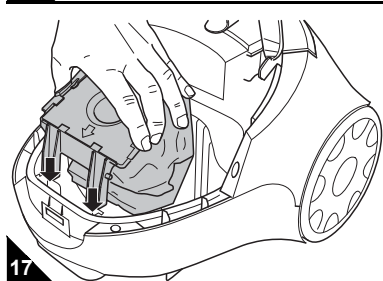
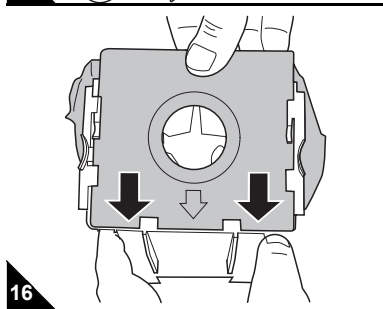
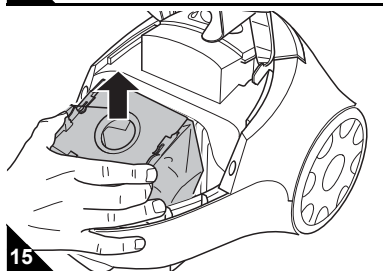



### 3 Manutenzione

**Royal**

#### 3.1 Vista d'insieme dei filtri

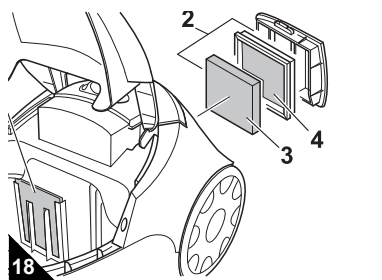

Dopo qualche tempo i filtri possono sporcarsi e pertanto devono essere controllati regolarmente.

##### Sono installati i seguenti filtri:

- Filtro di protezione del motore (Fig. 18/1)  
Nel caso il sacchetto del filtro della polvere sia difettoso, impedisce alle particelle piuttosto grosse di danneggiare il motore.  
- *Sostituzione: a ogni 5° cambio del sacchetto del filtro della polvere, al più tardi ogni 6 mesi* (▷ Capitolo 3.3, "Pulizia del filtro di protezione del motore").
- Unità filtro dell'aria uscente (Fig. 18/2) composta da
  - **Elemento filtro in espanso (Fig. 18/3) e**
  - **Portafiltra con TNT cucito all'interno (Fig. 18/4)**
 L'unità filtro dell'aria uscente filtra le particelle finissime dell'aria soffiata fuori.  
- *Sostituzione: ogni 6 mesi* (▷ Capitolo 3.2, "Pulizia dell'unità filtro dell'aria uscente").

#### 3.2 Pulizia dell'unità filtro dell'aria uscente

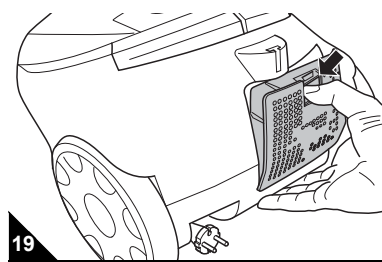

19

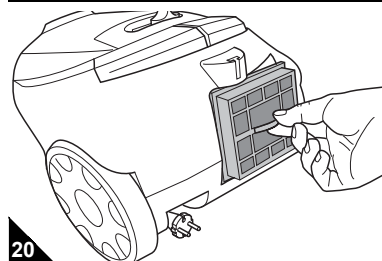

20

1. Spegner l'apparecchio e staccare la spina dalla presa elettrica, ▷ Capitolo 2.3, "Spegnimento".
2. Premere lo sblocco del coperchio del filtro dell'aria uscente ed aprire tale coperchio (Fig. 19).
3. Rimuovere l'unità filtro dell'aria uscente dalla relativa mensola afferrandola per l'apposita linguetta (Fig. 20).
4. Tenere l'unità filtro dell'aria uscente rasente sopra a un secchio delle immondizie.
5. Rimuovere l'elemento filtro in espanso dal portafiltra.
6. Sciacquare accuratamente i due elementi filtro a mano con acqua fredda pulita.

##### ⚠ ATTENZIONE:

Gli elementi filtro dell'unità filtro dell'aria uscente sono lavabili, ma non sono idonei né per il lavaggio in lavatrice né per quello in lavastoviglie. Inoltre per la pulizia non usare detersivi. Infine lasciar asciugare gli elementi filtro (per circa 24 ore a temperatura ambiente). Rimontarli soltanto quando sono completamente asciutti.

7. Se uno degli elementi filtro è danneggiato o deformato, sostituirlo con uno nuovo (▷ Capitolo 3.4, "Elenco degli accessori e ricambi").
8. Rimontare l'elemento filtro in espanso pulito/nuovo nel portafiltra.
9. Quindi rimettere il portafiltra appena riequipaggiato nella relativa mensola (Fig. 20). La linguetta di rimozione del portafiltra deve essere rivolta verso l'esterno dell'apparecchio.
10. Agganciare il coperchio del filtro dell'aria uscente prima sotto e poi premerlo da sopra finché scatta percettibilmente in posizione (Fig. 19).

#### 3.3 Pulizia del filtro di protezione del motore

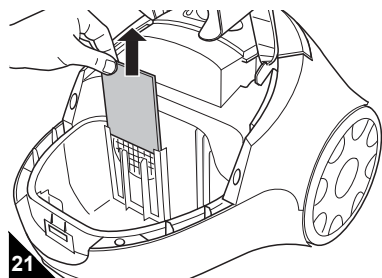

21

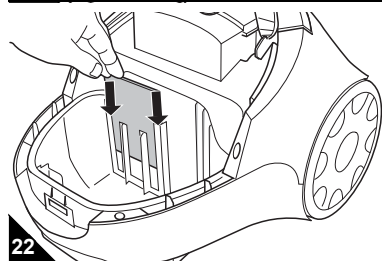

22

1. Spegner l'apparecchio e rimuovere il portasacchetto unitamente al sacchetto del filtro della polvere, ▷ Capitolo 2.5, "Cambio del sacchetto del filtro della polvere", punti 1-4.
2. Estrarre il filtro di protezione del motore dalla relativa guida tirandolo verso l'alto (Fig. 21).
3. Sciacquare il filtro di protezione del motore a mano con acqua fredda pulita.

##### ⚠ ATTENZIONE:

Il filtro di protezione del motore è lavabile, ma non idoneo né per il lavaggio in lavatrice né per quello in lavastoviglie. Inoltre per la pulizia non usare detersivi. Quindi far asciugare il filtro di protezione del motore (per circa 24 ore a temperatura ambiente). Rimontarlo soltanto quando è completamente asciutto.

4. Qualora il filtro di protezione del motore dovesse essere danneggiato o deformato, sostituirlo con uno nuovo (▷ Capitolo 3.4, "Elenco degli accessori e ricambi").
5. Rispingere il filtro di protezione del motore nelle apposite guide (Fig. 22/freccia).
6. Inserire il portasacchetto con il sacchetto del filtro della polvere e chiudere il coperchio del vano sacchetto. Scatta percettibilmente in posizione.

#### 3.4 Elenco degli accessori e ricambi

| Codice articolo | Descrizione   |
|-----------------|---|
| 7010022         | Set con 5 sacchetti del filtro della polvere e 1 filtro di protezione del motore                          |
| 7011002         | 1 unità filtro dell'aria uscente (incl. elemento filtro in espanso (Fig. 18/3) e portafiltra (Fig. 18/4)) |
| M203            | 1 spazzola per parquet  |
| M209            | 1 spazzola turbo  |

#### 3.5 Fornitori di accessori e ricambi

- Contatto per le ordinazioni ▷ pagina 40, "International Service".
- Per ulteriori informazioni si rimanda a <http://www.dirtdevil.de>

#### 3.6 Consiglio



Consigliamo di riacquistare: *Sacchetti filtro della polvere Swirl® Y05 con filtrazione MicroPor®*

##### INDICAZIONE:

Inserire il sacchetto nella direzione "C".

Swirl®, MicroPor® e "Y05" sono marchi registrati di un'azienda del Gruppo Melitta, utilizzati con il consenso della stessa.





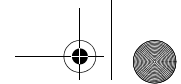

## 4 Risoluzione dei problemi

**Royal**

### 4.1 Prima di inviare l'apparecchio

Prima di contattare il rivenditore contrattuale Royal competente, il partner dell'assistenza Royal o il punto vendita specializzato verificare, in base alla seguente tabella, se è possibile risolvere autonomamente il problema.

**AVVERTIMENTO:**

Pericolo di lesioni! Non usare mai l'apparecchio se è difettoso! Prima di procedere alla diagnostica, spegnere l'elettrodomestico e staccarne la spina, > *Capitolo 2.3, "Spegnimento"*.

| Problema  | Causa possibile  | Rimedio  |
|---|--|--|
| Non si riesce ad accendere l'apparecchio.   | Spina non inserita.  | Inserire la spina in una presa elettrica e accendere l'apparecchio, > <i>Capitolo 2.2, "Aspirare"</i> .  |
|   | La presa non conduce corrente.   | Provare a collegare l'aspirapolvere a un'altra presa sicuramente conduttrice di corrente.  |
|   | Il cavo elettrico è danneggiato.   | Far sostituire il cavo di alimentazione dall'assistenza clienti Royal Appliances, indirizzo > <i>pagina 40, "International Service"</i> .  |
| L'apparecchio smette improvvisamente di aspirare.   | La protezione dai surriscaldamenti è scattata (forse a causa di condutture di aspirazione ostruite o altro). | Spegnere l'apparecchio e staccarne la spina dalla presa elettrica. Eliminare la causa del surriscaldamento (ad es. condutture di aspirazione ostruite o altro). Attendere circa 45 minuti. L'apparecchio raffreddato può quindi essere riacceso. |
| L'indicatore di cambio del sacchetto del filtro della polvere è su "rosso"                  | Il sacchetto del filtro della polvere è troppo pieno.  | Sostituire il sacchetto del filtro della polvere > <i>Capitolo 2.5, "Cambio del sacchetto del filtro della polvere"</i> .  |
|   | La bocchetta, il tubo telescopico o il flessibile di aspirazione sono ostruiti.                              | Eliminare l'ostruzione eventualmente utilizzando un bastone lungo (ad es. un manico di scopa).   |
|   | Il filtro è sporco.  | Pulire il relativo filtro, > <i>Capitolo 3.2, "Pulizia dell'unità filtro dell'aria uscente"</i> o > <i>Capitolo 3.3, "Pulizia del filtro di protezione del motore"</i> .   |
| Nonostante il funzionamento sia perfetto, il risultato dell'aspirazione non è soddisfacente | Il regolatore dell'aria secondario (Fig. 1/5) è aperto.  | Chiudere il regolatore dell'aria secondario (Fig. 1/5).  |
|   | Il sacchetto del filtro della polvere è troppo pieno.  | Sostituire il sacchetto del filtro della polvere > <i>Capitolo 2.5, "Cambio del sacchetto del filtro della polvere"</i> .  |
|   | La bocchetta, il tubo telescopico o il flessibile di aspirazione sono ostruiti.                              | Eliminare l'ostruzione eventualmente utilizzando un bastone lungo (ad es. un manico di scopa).   |
|   | Il filtro è sporco.  | Pulire il relativo filtro, > <i>Capitolo 3.2, "Pulizia dell'unità filtro dell'aria uscente"</i> o > <i>Capitolo 3.3, "Pulizia del filtro di protezione del motore"</i> .   |
| L'apparecchio produce un rumore insolitamente forte   | Particelle risucchiate ostruiscono il percorso dell'aria.  | Rimuovere le particelle eventualmente utilizzando un bastone lungo (ad es. un manico di scopa).  |

**INDICAZIONE:**

Se non si è riusciti a eliminare il problema con l'ausilio della presente tabella, contattare il servizio assistenza Royal (> *pagina 40, "International Service"*).

### 4.2 Smaltimento



I filtri impiegati sono fabbricati con materiali ecocompatibili e possono essere smaltiti tramite i normali rifiuti domestici. Quando l'apparecchio giunge alla fine della vita di servizio, in particolare se si manifestano anomalie funzionali, renderlo inservibile staccando la spina dalla presa e tagliando il cavo. Smaltire l'apparecchio in conformità alla normativa ambientale vigente localmente. I rifiuti elettrici non devono essere smaltiti assieme a quelli domestici. Per consigli sul riciclaggio rivolgersi alle autorità municipali o al rivenditore.

### 4.3 Condizioni di garanzia

Per questo apparecchio da noi venduto forniamo la garanzia di legge di 24 mesi dalla data d'acquisto. Entro detto periodo di garanzia eliminiamo gratuitamente tutti i difetti dovuti a vizi dei materiali o di fabbricazione, a nostra discrezione, tramite riparazione o sostituzione dell'apparecchio o degli accessori (eventuali danni a carico degli accessori non portano automaticamente alla sostituzione dell'intero apparecchio). Dalla garanzia sono esclusi i danni imputabili ad impieghi non conformi alla destinazione d'uso (funzionamento con tipo di corrente/tensione errati, collegamento a sorgenti elettriche non idonee, rottura, ecc.), normale usura e difetti che influenzano solo minimamente il valore d'uso o l'idoneità all'impiego dell'apparecchio. Eventuali interventi eseguiti da centri non debitamente autorizzati o l'utilizzo di ricambi diversi da quelli originali Royal Appliances fanno decadere la garanzia. I componenti soggetti a usura non sono coperti da garanzia e quindi a pagamento! La garanzia entra in vigore soltanto se la data d'acquisto è comprovata dal timbro e la firma del rivenditore sull'apposito tagliando di garanzia o se l'apparecchio è inviato corredato da una copia della fattura. Le prestazioni in garanzia non comportano proroghe della durata della garanzia, né danno diritto a una nuova garanzia!

### 4.4 Per le prestazioni in garanzia

Spedire l'apparecchio senza sacchetto del filtro della polvere e corredato da una breve descrizione dell'anomalia, scritta in stampatello. Sulla lettera d'accompagnamento indicare la dicitura "Per garanzia". Inviare unitamente al tagliando di garanzia o a una copia della fattura al seguente indirizzo: > *pagina 40, "International Service"*





## 1 Genel bakış ve güvenlik



### Teşekkür ederiz!

Ürünümüz POPSTER'yi satın aldığınız ve bize duyduğunuz güven için teşekkür ederiz.

### Genel Bakış (Res. 1):

- 1 a: Toz bölmesi kapağı için kilit;  
b: Taşıma için sap boşluğu
- 2 Emme hortumu için kilit düğmesi
- 3 Toz filtresi torbası değiştirme göstergesi
- 4 Teleskobik boru kilidi
- 5 Ek hava regülatörü
- 6 Emme gücü ayarı
- 7 Açma/Kapama şalteri
- 8 Kablo toplama düğmesi
- 9 Dışa üfleme filtresi kapağı açma kilidi
- 10 "Halı/sert zemin" ayar mandalı

### Res. 2:

- 1 Motor koruma filtresi
- 2 Dışa üfleme filtresi birimi, aşağıdakileri ihtiva eder:
- 3 Köpük filtre elemanı
- 4 İçe dikilmiş keçeli filtre tutacağı

### Res. 3:

- 1 Tutma tertibatına sahip kağıt toz filtresi torbası (cihaz içinde)
- 2 ayrı bir kağıt toz filtresi torbası (karton içinde)
- 3 Kullanma Talimatı

### Res. 4:

- 1 Donanım tutma tertibatı
- 2 Döşeme fırçası
- 3 Aralık temizleme parçası olarak 2'si 1 arada kombi süpürme parçası
- 4 Mobilya fırçası olarak 2'si 1 arada kombi süpürme parçası

### Res. 5:

\*opsiyonel donanım:

- 1 \*Parke fırçası (M203): hassas yüzeylerin temizlenmesi için (örn. laminat, parke)
- 2 \*Turbo fırça (M209): döner fırça başı ile halıların derinlemesine temizlenmesi için

### Teknik Veriler

|                           |  |
|---------------------------|--|
| Cihaz türü                | : Elektrikli süpürge                         |
| Model                     | : POPSTER M7012 (-0/.../9)                   |
| Gerilim                   | : 220 – 240 V~, 50/60 Hz                     |
| Güç                       | : 1.400 W nom.– 2.000 W maks                 |
| Toz torbası hacmi         | : Maks. kullanılabilir dolun hacmi 1,5 litre |
| Elektrik kablosu uzunluğu | : yaklaşık 5 m                               |
| Ağırlık                   | : yaklaşık 4,5 kg                            |



Sürekli ürün iyileştirme kapsamında teknik değişiklik ve şekil değişikliği yapma hakkı saklıdır.  
© Royal Appliance International GmbH

### 1.1 Kullanma Talimatına ilişkin olarak

Cihazla çalışmaya başlamadan önce bu Kullanma Talimatını tamamen okuyun. Talimatı her zaman bulabileceğiniz bir yerde muhafaza edin. Cihazı üçüncü kişilere verdiğinizde, bu Kullanma Talimatını da beraberinde verin.

Güvenliğiniz açısından önemli açıklamalar, ayrı şekilde işaretlenmişlerdir. Kazaları ve cihazda meydana gelebilecek zararları önlemek için bu açıklamalara mutlaka uyun:

#### ⚠ Uyarı:

Sağlığınız açısından söz konusu tehlikelere karşı uyarır ve olası yaralanma risklerine işaret eder.

#### ⚠ Dikkat:

Cihaza veya başka nesnelere yönelik olası tehlikelere dikkat çeker.

#### Açıklama:

Sizin için önemli önerileri ve bilgileri gösterir.

#### Bu Talimatın dikkate alınmaması, ağır yaralanmalara veya cihazda zararlara sebebiyet verebilir.

Bu Kullanma Talimatının dikkate alınmaması sebebiyle meydana gelen zararlar için herhangi bir sorumluluk üstlenmeyiz.

### 1.2 Çocuklara ilişkin olarak

■ Bu cihaz, eğer güvenliklerinden sorumlu bir kişi tarafından denetlenmiyorsa veya cihazı nasıl kullanacaklarına dair talimat almamışlarsa, sınırlı fiziksel, duyuşsal veya zihinsel yetilere veya deneyimsiz ve/veya bilgi sahibi olmayan kişiler tarafından (çocuklar dahil) kullanılmaya uygun değildir. Cihazla oynamalarını temin etmek için çocuklar sürekli gözlenmelidir. Cihazı bu kişilere yönelik olarak erişemeyecekleri şekilde muhafaza edin.

■ Ambalaj materyali oyun için kullanılmamalıdır. Boğulma tehlikesi vardır.

### 1.3 Amaca uygun kullanıma ilişkin olarak

- Elektrikli süpürge sadece evde kullanılmalıdır. Sınai bir kullanım için uygun değildir.
- Elektrikli süpürgeyi sadece kuru, normal kirli zeminlerin, halıların ve tüllerin temizliğinde kullanın.

#### Her türlü farklı kullanım, amaca uygun olmayan kullanım olarak kabul edilir ve yasaktır.

#### Özellikle yasak olan hususlar:

- El süpürgesinin aşağıdakilerin temizliğinde kullanılması yasaktır:
  - Vücut uzuvları ve hayvanlar. Bunlar içeri çekilebilir ve yaralanabilir.
  - Giyimli eşyalar. Bunlar içeri çekilebilir ve yaralanmaya sebebiyet verebilir.
  - Su ve diğer sıvılar, özellikle nemli halı temizlik maddeleri. İç kısımda nem, kısa devreye neden olabilir.
  - Toner tozu (lazerli yazıcılar, fotokopiler vs. için) Yangın ve patlama tehlikesi mevcuttur.
  - Kor halindeki kül, yanan sigaralar veya kibritler. Yangın çıkabilir.
  - Cam kırıkları, iğneler vs. gibi sivri nesnelere. Cihaz zarar görebilir.
  - İnşaat atığı, alçı, çimento, ince matkap tozu, makyaj malzemesi vs. Cihaz zarar görebilir.
- Patlayıcı veya kolay yanıcı maddelerin yakınında kullanım. Yangın veya patlama tehlikesi mevcuttur.
- Açık havada kullanım. Yağmur ve kirin cihazı bozma tehlikesi vardır.
- Cihazın açıklıkları içine yabancı maddelerin sokulması. Yaralanma tehlikesi vardır.
- Cihazın kendi başına modifiye edilmesi veya tamir edilmesi. Yaralanma tehlikesi vardır.

### 1.4 Elektrik beslemesine ilişkin olarak

■ Cihaz elektrikle işletilmekte olup, burada prensip olarak elektrik çarpması tehlikesi söz konusudur. Bu nedenle özellikle aşağıdaki hususlara dikkat edin:

- Priz/fişi asla ıslak ellerle ellemeyin.
- Fişi prizden çekeceğiniz zaman, her zaman doğrudan fişten çekin. Asla elektrik kablosundan çekmeyin, bunun kopma tehlikesi vardır.
- Elektrik kablosunun bükülmemesine, sıkışmamasına, üzerinden ağır nesnelere geçmemesine veya ısı kaynakları ile temas etmemesine dikkat edin.
- Sadece cihazın güç sarfiyatı için uygun şekilde tasarlanmış uzatma kabloları kullanın.
- Cihazı asla suya veya başka sıvılara daldırmayın ve yağmurdan ve nemden uzak tutun.
- Cihazı sadece, model etiketi üzerinde belirtilen elektrik gerilimi, prizinizin gerilimi ile özdeş olduğunda çalıştırın. Yanlış gerilim cihaza zarar verebilir.

### 1.5 Arızalı cihazda

■ Asla arızalı bir cihazı veya arızalı bir elektrik kablosuna sahip bir cihazı çalıştırmayın. Bu cihazın bağlantı hattı zarar gördüğünde, tehlikelerin önlenmesi için, bunun üretici tarafından veya müşteri hizmetleri tarafından veya benzer yetkili bir kişi tarafından değiştirilmesi gerekir.

■ Arızalı bir cihazı tamir için yetkili satıcınıza veya Royal Appliance-Müşteri Hizmetlerine yollayın. Adres > Sayfa 40, „International Service“.

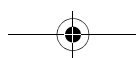



## 2 Kullanım

**Royal**

### 2.1 Ambalajdan çıkarma ve monte etme

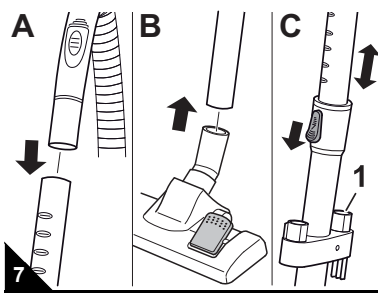
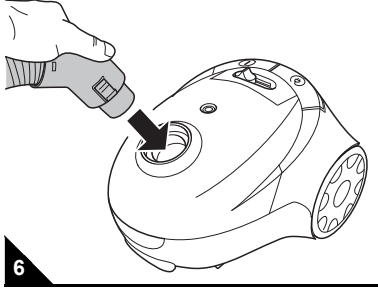

1. Cihazı komple donanımı ile ambalajından çıkarın.
2. İçeriği, hasarsız ve eksiksiz olmasına ilişkin olarak kontrol edin (Res. 1-5).

#### Açıklama:

Eğer taşımadan kaynaklı bir zarar tespit ederseniz, hemen satıcınıza danışın.

#### ⚠ Dikkat:

Cihazı, zarar görmemesi için, prensip olarak orijinal ambalajında taşıyın/gönderin. Bunun için orijinal ambalajı muhafaza edin.  
Gerekli olmayan ambalaj materyalini düzgün şekilde atın/imha edin.

#### ⚠ Uyarı:

Yaralanma tehlikesi! Cihazı sadece, fiş prizden çekildiğinde monte edin. Aksi takdirde cihaz çalışabilir ve vücut organlarını, saçları veya giyim parçalarını içeri çekebilir.

3. Emme hortumunun ucunu, resimde gösterildiği gibi giriş açıklığı içine, kilit duyulabilir ve hissedilebilir şekilde kilitlemeye kadar sokun (Res. 6/A).
4. Sapı, teleskobik borunun üst ucuna sokun (Res. 7/A).
5. Arzu ettiğiniz süpürme parçasını teleskobik boru üzerine takın (Res. 7/B).
6. Teleskobik borunun uzunluğunu ayarlayın. Bunun için teleskobik boru kilidini aşağıya bastırın (Res. 7/C). Teleskobik boruyu, arzu ettiğiniz uzunluğa çekerek ayarlayın. Kilitleme için teleskobik boru kilidini çekerken bırakın. Belirgin bir klik sesi duyacaksınız.
7. Olası olarak gerekli olmayan aksamı resimdeki gibi emme borusundaki donanım tutma birimine yerleştirin (Res. 7/C1).

Elektrikli süpürge artık kullanıma hazır.

### 2.2 Süpürme

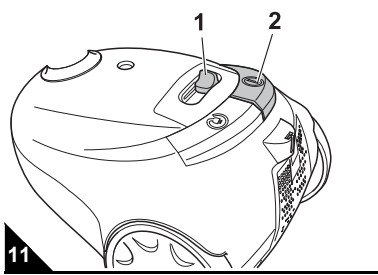
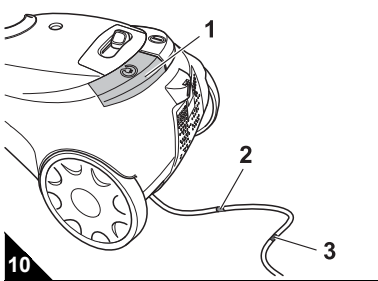
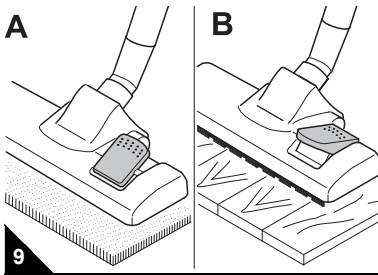
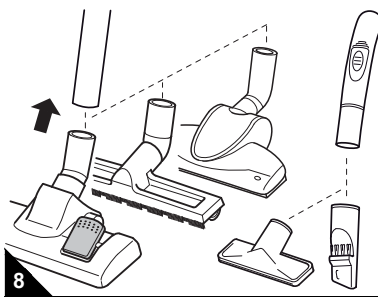

#### ⚠ Uyarı:

Yaralanma tehlikesi! Hasar görmüş cihaz kullanılmamalıdır. Elektrikli süpürgeyi ve elektrik kablosunu her kullanımdan önce kontrol edin.

#### ⚠ Uyarı:

Yaralanma tehlikesi! Özellikle merdivenleri süpürürken, her zaman cihazın yukarısında bulunmaya dikkat edin.

#### ⚠ Dikkat:

Elektrikli süpürgeyi sadece, tüm filtreler sağlam, kuru ve düzgün şekilde takılı olduğunda kullanın. Açıklıkların tıkanmamış olduğundan emin olun. Aksi takdirde elektrikli süpürge zarar görebilir.

#### Açıklama:

Elektrikli süpürge bir aşırı ısınma korumasına sahiptir. Aşırı ısınma durumunda otomatik olarak kapanır. Bu durum söz konusu olduğunda, elektrik süpürgeyi kapatın ve fişi prizden çekin. Aşırı ısınma sebebinin giderin. Yaklaşık 45 dakika bekleyin. Soğumuş elektrik süpürgeyi tekrar açabilirsiniz.

1. Arzu ettiğiniz parçayı takın (Res. 8).

#### ⚠ Dikkat:

Kaplama üreticilerinin tavsiyelerini ve ilgili süpürme parçasının ilgili kaplama için uygun olup olmadığını dikkate alın.

2. "Halı/sert zemin" ayar mandalını, yer süpürme parçasının kullanımında, her defasındaki zemin kaplamasına uygun ayarlayın:
  - **Halı (Res. 9/A):** uzun / kısa tüylü halılar, kilimler vs. için
  - **Sert zemin (Res. 9/B):** Laminat, fayans, PVC vs. için
3. Elektrik kablosunu sarı işarete kadar (Res. 10/3) dışarı çekin.

#### ⚠ Uyarı:

Elektrik çarpması tehlikesi! Kırmızı işaret (Res. 10/2) görünüyorsa, kabloyu kablo toplama düğmesi (Res. 10/1) sarı işarete (Res. 10/3) kadar tekrar içeri çekin. Aksi takdirde kablo zarar görebilir.

4. Fişi, koruma kontağı olan bir prize takın.
5. Elektrikli süpürgeyi açma/kapama şalterinden (Res. 11/2) açın.
6. Emme gücü ayarını (Res. 11/1) her defasında temizlenecek zemine göre ayarlayın.
7. Elektrikli süpürgeyi, temizleme için bir kızak gibi arkanızdan çekin.

#### Açıklama:

Ek hava regülatörü (Res. 1/5) ile emme gücünü, örn. içeri çekilmiş nesnelere tekrar dışarıya çıkarabilmek için daha az emme gücü gerektiğinde, hızlı şekilde düşürebilirsiniz.

TR

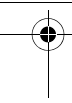

## 2 Kullanım

 **Royal**

### 2.3 Kapatma

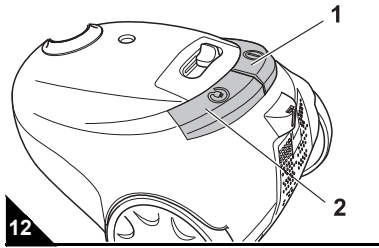

### 2.4 Nakliye ve kaldırma

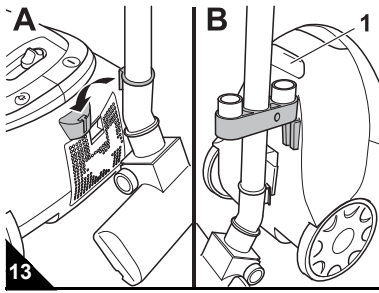

### 2.5 Toz filtresi torbasını değiştirme

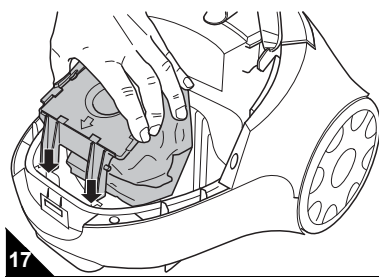
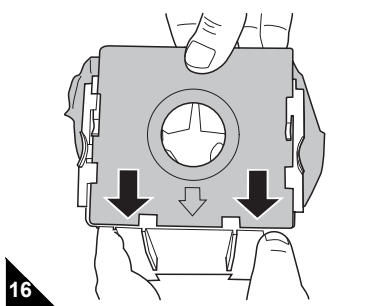
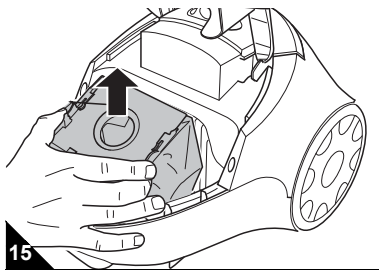
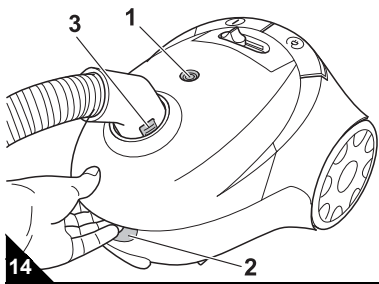

1. Elektrikli süpürgeyi açma/kapama şalterinden (Res. 12/1) kapatın ve fişi prizden çekin.
2. Fişi elinizde tutun.

#### ⚠ Uyarı:

Yaralanma tehlikesi! Elektrik kablosunun kontrolsüz şekilde içeri toplanmasında bu kişilerin ve eşyaların ayaklarına dolanabilir, düşmeye sebep olan bir tuzak haline gelebilir veya nesnelere devirebilir. Bu yüzden fişi elinizde tutun ve elektrik kablosunu toplamak için içeri çekerken elinizde kontrol edin.

3. Elektrik kablosunu toplamak için kablo toplama düğmesine (Res. 12/2) basın.

- Taşıma için cihazı taşıma sapından (Res. 13/B1) taşıyabilirsiniz.
- Çalışma aralarında park kancasını park tutma birimine asabilirsiniz (Res. 13/A).
- Kaldırma için muhafaza etme kancasını muhafaza etme tutacağı içine asabilirsiniz (Res. 13/B).
- Teleskobik borunun önce kapatılması tavsiye edilir ▷ Bölüm 2.1, „Ambalajdan çıkarma ve monte etme“, adım 4).

#### ⚠ Dikkat:

Cihazı asla doğrudan ısı kaynakları yanına koymayın (örn. kalorifer, soba). Doğrudan güneş ışığı almasını engelleyin. Isı, cihaza zarar verebilir.

- Uzun süreli bir kaldırma için toz kabını ▷ Bölüm 2.5, „Toz filtresi torbasını değiştirme“ çıkarın ve bunu düzgün şekilde atın/imha edin. Cihazı her zaman serin, kuru ve çocukların erişemeyeceği bir yerde bulundurun.

#### ⚠ Dikkat:

Toz filtresi torbasını değiştirmeden önce cihazı kapatın. Böylece tozun cihaza zarar vermesini engellersiniz.

- Toz filtresi torbası değiştirme göstergesi (Res. 14/1) "kırmızı" yandığında, uzun süreli depolama veya sevk etme durumunda toz filtresi torbasını değiştirin.
- Ayrıca toz filtresi torbasını hijyenik gerekçeyle en geç her 3 ayda bir değiştirin.

1. Cihazı kapatın ve fişi prizden çekin, ▷ Bölüm 2.3, „Kapatma“.
2. Kilit düğmesine basarak (Res. 14/2) ve akabinde katlayıp açarak toz bölmesi kapağını açın.
3. Toz bölmesi kapağını, hissedilebilir şekilde kilitlene ve kendiliğinden açık kalana kadar katlayıp açın.

#### Açıklama:

Toz bölmesi kapağı kendiliğinden açık kalmazsa, emme hortumunun önceden çıkarılması tavsiye edilir. Bunun için her iki kilit düğmesine (Res. 14/3) basın ve emme hortumunu, girişinden dışarıya çekin.

4. Toz torbası tutacağına, toz filtresi torbası ile birlikte gösterildiği gibi (Res. 15) yukarıya çekerek çıkarın.

#### Açıklama:

Tozun toz filtresi torbasından dışarıya çıkmaması için toz filtresi torbasının çıkarılmasında dikkatli hareket edin.

5. Dolu toz filtresi torbasını yukarıya doğru, toz torbası tutacağından dışarıya çekin (Res. 16).

#### Açıklama:

Toz filtresi torbası muhteviyatını, ev atığıyla yasak olan bir kir ihtiva etmediği sürece, ev çöpü ile birlikte atabilirsiniz/imha edebilirsiniz.

6. Yeni toz filtresi torbasını resimdeki gibi, her iki çıkıntı arkasına ve toz torbası tutacağına tam kenarına bitişene kadar toz torbası tutacağı içine itin (Res. 16, oklar).
7. Olası olarak toz bölmesinde bulunan toz artıklarını temizleyin.
8. Bu fırsatla aynı anda motor koruma filtresini kontrol edin. İhtiyaç halinde bunu değiştirin, ▷ Bölüm 3.3, „Motor koruma filtresinin temizlenmesi“.
9. Toz torbası tutacağına yeni toz filtresi torbası ile birlikte tekrar yerine takın:
  - Bunun için toz torbası tutacağına, bunun için öngörülen iki ray içine yerleştirin (Res. 17/oklar).
  - Toz torbası tutacağına sonra, bu, güvenli şekilde kılavuzu üzerine yerleşene kadar bastırın.

#### Açıklama:

Toz bölmesi kapağı sadece, toz filtresi torbası yerleştirildiği zaman kapanır.

10. Toz bölmesi kapağını kapatın. Bu, duyulabilir şekilde kilitlenir.

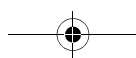



### 3 Bakım

**Royal**

#### 3.1 Filtrelere genel bakış

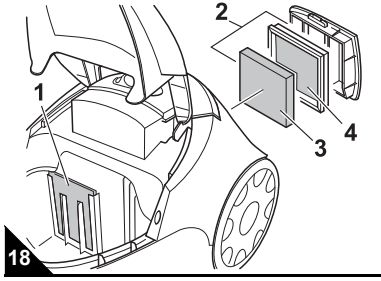

Filtreler belirli bir zaman sonra kirlenirler ve bu yüzden düzenli olarak kontrol edilmelidirler:

**Aşağıdaki filtreler monte edilmiştir:**

■ **Motor koruma filtresi (Res. 18/1)**

Bu, arızalı toz filtresi torbasında, büyük partiküllerin motora zarar vermesini engeller.

- *Değiştirme: her 5. toz filtresi torbası değişiminde, en geç 6 ayda bir (► Bölüm 3.3, „Motor koruma filtresinin temizlenmesi“).*

■ **Dışa üfleme filtresi birimi (Res. 18/2), aşağıdakileri ihtiva eder:**

- **Köpük filtre elemanı (Res. 18/3) ve**
- **içe dikilmiş keçeli filtre tutacağı (Res. 18/4)**

Dışa üfleme filtresi birimi dışa üflenen havadan en ince partikülleri filtreler.

- *Değiştirme: her 6 ayda bir (► Bölüm 3.2, „Dışa üfleme filtresi birimini temizleme“).*

#### 3.2 Dışa üfleme filtresi birimini temizleme

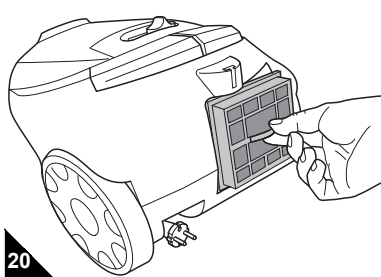
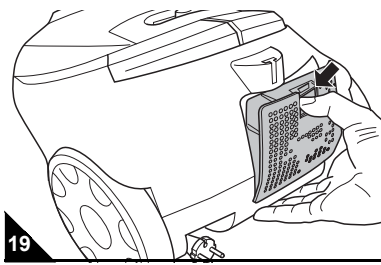

1. Cihazı kapatın ve fişi prizden çekin, ► *Bölüm 2.3, „Kapatma“.*
2. Dışa üfleme filtresi kapağının kilidine basın ve kapağı açın (Res. 19).
3. Dışa üfleme filtresi birimini, bunun için öngörülen dilinden konsoldan çıkarın (Res. 20).
4. Dışa üfleme filtresi birimini bir çöp kovası üzerinde tutun.
5. Köpük filtre elemanını filtre tutacağından çıkarın.
6. Her iki filtre elemanını elle, temiz, soğuk suyla iyice temizleyin.

**⚠ Dikkat:**

Dışa üfleme filtresi biriminin filtre elemanları yıkanabilir, ancak ne bulaşık makinesinde, ne de çamaşır makinesinde yıkanmaya uygun değildir. Ayrıca temizlik için temizleme maddeleri kullanmayın. Akabinde filtre elemanlarını kurutmaya bırakın (oda sıcaklığında yaklaşık 24 saat). Parçaları, ancak tamamen kuruduktan sonra tekrar yerine takın.

7. Eğer filtre elemanlarından biri zarar görürse veya deforme olursa, bunu yenisiyle değiştirin (► *Bölüm 3.4, „Donanım ve yedek parça listesi“*).
8. Temizlenmiş/yeni köpük filtre elemanını filtre tutacağı içine geri yerleştirin.
9. Yeni donatılan filtre tutacağı şimdi konsolu içine geri takın (Res. 20). Filtre tutacağına çıkarma dili burada cihazdan dışarıya doğru olmalıdır.
10. Dışa üfleme filtresi kapağını kancasından önce alttan yerine takın ve sonra üstten, hissedilebilir şekilde yerine geçene kadar bastırın (Res. 19).

#### 3.3 Motor koruma filtresinin temizlenmesi

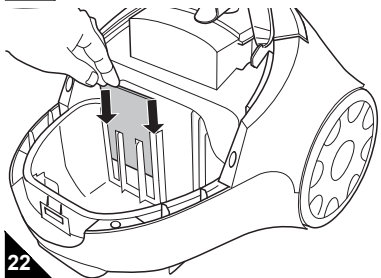
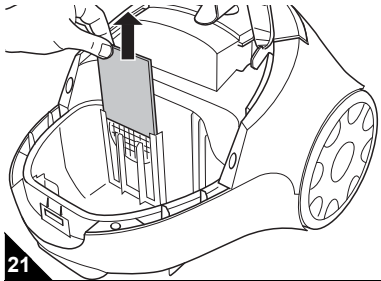

1. Cihazı kapatın ve toz torbası tutacağına toz filtresi torbası ile birlikte çıkarın, ► *Bölüm 2.5, „Toz filtresi torbasını değiştirme“*, adımlar 1–4.
2. Motor koruma filtresini kılavuzundan yukarıya çekin (Res. 21).
3. Motor koruma filtresini elle, temiz, soğuk suyla iyice temizleyin.

**⚠ Dikkat:**

Motor koruma filtresi yıkanabilir, ancak ne bulaşık makinesinde, ne de çamaşır makinesinde yıkanmaya uygun değildir. Ayrıca temizlik için temizleme maddeleri kullanmayın. Akabinde motor koruma filtresini kurutmaya bırakın (oda sıcaklığında yaklaşık 24 saat). Parçayı, ancak tamamen kuruduktan sonra tekrar yerine takın.

4. Eğer motor koruma filtresi hasar görmüşse veya deforme olmuşsa, bunu yenisiyle değiştirin (► *Bölüm 3.4, „Donanım ve yedek parça listesi“*).
5. Motor koruma filtresini tekrar bunun için öngörülen kılavuzlar içine itin (Res. 22/oklar).
6. Toz filtresi torbasına sahip toz torbası tutacağına yerleştirin ve toz bölmesi kapağını kapatın. Bu, duyulabilir şekilde kilitletir.

#### 3.4 Donanım ve yedek parça listesi

| Ürün no. | Tanımlama  |
|----------|--|
| 7010022  | 5 toz filtresi torbasına ve 1 motor koruma filtresine sahip set  |
| 7011002  | 1 dışa üfleme filtresi birimi (muhteviyatı: köpük filtre elemanı (Res. 18/3) ve filtre tutacağı (Res. 18/4)) |
| M203     | 1 parke fırçası  |
| M209     | 1 Turbo fırça  |

#### 3.5 Tedarik kaynakları

- Sipariş iletişimi ► *Sayfa 40, „International Service“.*
- Ayrıntılı bilgi için bakınız <http://www.dirtdevil.de>

#### 3.6 Satış tavsiyesi



Almanızı tavsiye ederiz: *Swirl® Y05 toz filtresi torbası, MicroPor® filtrasyon* ile birlikte

**Açıklama:**

Torbayı "C" yönünde yerleştirin.

Swirl®, MicroPor® ve "Y05", Melitta Grubunun bir işletmesinin, ilgili işletmenin izniyle kullanılan, tescilli markalardır.

TR



## 4 Sorun Giderme



### 4.1 Cihazı geri göndermeden

Yetkili Royal satıcısını, Royal servis ortağını veya uzman teknik servisi aramadan önce, aşağıdaki tablodan, sorunu kendiniz giderip gidemeyeceğinize bakın.

#### ⚠ Uyarı:

Yaralanma tehlikesi! Asla arızalı bir cihazı kullanmayın! Sorunu aramadan önce, cihazı kapatın ve fişini çekin, ▷Bölüm 2.3, „Kapatma“.

| Sorun   | Olası sebep   | Çözüm  |
|---|---|--|
| Cihaz açılmıyor.  | Fiş takılı değil.   | Fişi bir prize takın ve cihazı çalıştırın, ▷Bölüm 2.2, „Süpürme“.  |
|   | Prizden elektrik gelmiyor.  | Elektrik süpürGESİNİ, elektrik geldiğİnden emin olduğunuz başka bir prizde deneyin.  |
|   | Elektrik kablosu arızalı.   | Elektrik kablosunu Royal Appliance-Müşteri Hizmetlerine değİştİrtin, adres ▷Sayfa 40, „International Service“.   |
| Cihaz aniden emmeyi bırakıyor.                                | Aşırı ısınma koruması devrede (muhtemelen tıkanmış emme yolları vb. sebebiyle). | Cihazı kapatın ve fişi prizden çekin. Aşırı ısınma sebebini giderin (örn. tıkanmış emme yolları, vb.). Yaklaşık 45 dakika bekleyin. Soğumuş cihazı tekrar açabilirsiniz. |
| Toz filtresi torbası değİştİrme göstergesi "kırmızı"          | Toz filtresi torbası dolmuş.  | Toz filtresi torbasını değİştİrin ▷Bölüm 2.5, „Toz filtresi torbasını değİştİrme“.   |
|   | Süpürme parçası, teleskobik boru veya emme hortumu tıkanmış.                    | Tıkanmayı giderin. Bunun için gerekliyse uzun bir ahşap çubuk kullanın (örn. bir temizlik süpürGESİ SAPI).   |
|   | Filtre kirlİ.   | İlgili filtreyi temizleyin, ▷Bölüm 3.2, „Dışa üfleme filtresi birimini temizleme“ ya da ▷Bölüm 3.3, „Motor koruma filtresinin temizlenmesi“.                             |
| Kusursuz çalışmaya rağmen temizleme sonucu tatmin edici değİl | Ek hava regülatörü (Res. 1/5) açık.   | Ek hava regülatörünü (Res. 1/5) kapatın.   |
|   | Toz filtresi torbası dolmuş.  | Toz filtresi torbasını değİştİrin ▷Bölüm 2.5, „Toz filtresi torbasını değİştİrme“.   |
|   | Süpürme parçası, teleskobik boru veya emme hortumu tıkanmış.                    | Tıkanmayı giderin. Bunun için gerekliyse uzun bir ahşap çubuk kullanın (örn. bir temizlik süpürGESİ SAPI).   |
| Cihaz alışılmıŞın dışında gürültülü çalışıyor                 | Filtre kirlİ.   | İlgili filtreyi temizleyin, ▷Bölüm 3.2, „Dışa üfleme filtresi birimini temizleme“ ya da ▷Bölüm 3.3, „Motor koruma filtresinin temizlenmesi“.                             |
|   | Emilen partiküller hava yolunu tıkamış.   | Partikülleri temizleyin. Bunun için gerekliyse uzun bir ahşap çubuk kullanın (örn. bir temizlik süpürGESİ SAPI).   |

#### Açıklama:

Eğer sorunu bu tablo yardımıyla gideremediyse, Royal-Müşteri Hizmetlerinin servis çağrı hattını arayın (▷Sayfa 40, „International Service“).

### 4.2 Atma/İmha Etme



Kullanılan filtreler, çevre dostu materyallerden imal edilmişlerdir ve ev atığı ile birlikte atılabilirler/İmha edilebilirler. Kullanım ömrü dolduğunda, özellikle fonksiyon arızaları ortaya çıktığında, hizmet dışı cihazı, fiş prizden çekerek ve elektrik kablosunu ikiye ayırarak kullanılamaz hale getirin. Cihazı, ülkenizde geçerli çevre yönetmeliklerine uygun olarak atın/İmha edin. Elektriksel atıklar, ev atıkları ile birlikte atılamazlar/İmha edilemezler. Geri dönüşümle ilgili tavsiyeler için belediye makamlarıyla veya yetkili satıcınızla irtibata geçin.

### 4.3 Garanti Koşulları

**Tarafımızdan satılan cihaz için, satış tarihinden itibaren 24 ay şeklindeki yasal olarak öngörülen garantiyi tanıyoruz.**

Bu garanti mühleti dahilinde, seçimi bize ait olmak üzere cihazın veya donanımın tamiri veya değİştirilmesi vasıtasıyla (donanım parçalarındaki hasarlar, otomatik olarak komple cihazın değİştirilmesini gerektirmez) bedelsiz olarak, materyal veya üretim hatalarına dayalı tüm kusurları gideriyoruz. Amaca uygun olmayan kullanıma (yanlış elektrik türü/elektrik gerilimi ile İŞletim, uygunsuz elektrik kaynaklarına bağlantı, kırma vs.) dayalı zararlar, cihazın değİrini veya kullanım kapasitesini önemsiz şekilde etkileyen normal aşınma ve kusurlar, garanti kapsamı dışındadır. Tarafımızdan yetkilendirilmeyen yerler tarafından yapılan müdahalelerde veya orijinal Royal Appliance-yedek parçaları dışında parçaların kullanımında garanti iptal olur. Aşınabilir parçalar garanti kapsamına dahil değİldir ve bu nedenle ücrete tabidir! Garanti sadece, satış tarihi, satıcının garanti kartı üzerindeki mühür ve imzası ile onaylandığında veya gönderilen cihaza bir fatura fotokopisi/sureti ekli olduğunda yürürlüğe girer. Garanti edimleri/hizmetleri, ne garanti süresinin uzamasına etki ederler, ne de bu sebeple yeni bir garanti hakkı doğar!

### 4.4 Garanti durumunda

Cihazı, toz filtresi torbası olmaksızın ve düz yazıyla hatayı kısaca tarif ederek gönderin. Yazıya "garanti için" notunu düşün. Garanti kartı ile veya bir fatura fotokopisi/sureti ile birlikte bu Kullanma Talimatının arka sayfasında belirtilen adrese yollayın (▷Sayfa 40, „International Service“).

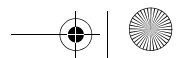
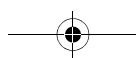



**International Service****DE**

Kundenservice:

Royal Appliance International GmbH  
Abt. Kundenservice  
Jagenbergstraße 19  
41468 Neuss  
DEUTSCHLAND  
Tel.: +49 (0) 180 - 501 50 50\*  
Fax: +49 (0) 2131 - 60 90 60 95  
www.dirtdevil.de  
info@dirtdevil.de

\*0,14 €/Minute aus dem deutschen Festnetz  
(deutscher Mobilfunkhöchstpreis 0,42 €/Minute)

**DE**

Zubehör und Ersatzteile:

Service-Versand  
Ina Riedmüller  
Frankenstraße 34  
89233 Neu-Ulm  
DEUTSCHLAND  
Tel.: +49 - 7307 - 51 75  
Fax: +49 - 7307 - 41 56  
Riedmueller.service@t-online.de

**DE**

Zubehör und Ersatzteile:

Service Center Feuerbach KG  
Corneliusstr. 75  
40215 Düsseldorf  
DEUTSCHLAND  
Tel.: +49 - 211 - 38 10 07  
Fax: +49 - 211 - 37 04 97  
dirtdevil-service@t-online.de  
www.dirtdevil-service.de

**AT**

Zmugg Elektronik Service  
und Vertriebsges. M.b.H.  
Fabriksgasse 27  
8020 Graz  
ÖSTERREICH  
Tel. +43 - 316 - 77 21 20  
Fax +43 - 316 - 77 21 20 10  
Tel. Ersatzteile: +43 - 316 - 77 21 20 14  
Fax Ersatzteile: +43 - 316 - 77 21 20 15  
zmuggelektronik@utanet.at

**BE**

Z.E.S. Goes B.V.  
T.a.v. afd. Service  
Pearyweg 1  
4462 GT Goes  
NEDERLAND  
Tel: +31 - 113 - 24 07 00  
Fax: +31 - 113 - 24 07 50  
dirtdevil@zesgoes.nl

**CH**

Bluepoint-Service SAGL  
Via Cantonale 14  
6917 Barbengo  
SWITZERLAND  
Tel. +41 (0) 91 980 49 73  
E-Mail: info@bluepoint-service.ch  
www.bluepoint-service.ch

**CZ**

Le Cygne electronic service spol. s r.o.  
Jablonecká 722/8  
190 00 Praha 9  
ČESKÁ REPUBLIKA  
Tel: +420 - 28 68 83 940  
Fax: +420 - 28 68 85 064  
servis@ice.cz

**ES**

Royal Appliance Espana, SL  
Royal, Dirt Devil, Stellar  
C/CRONOS, Nº 20 , PORTAL 2 ,3º 13  
28037 Madrid  
ESPAÑA  
Tel: +34 - 902 - 43 06 63

**FR**

OPM France Nant'Est entreprise  
33 rue du bois Briand  
44316 Nantes cdx 3  
FRANCE  
Tel. +33 - 2 - 40 49 64 25  
Fax +33 - 2 - 40 93 96 22  
www.opm-france.com

**HR**

TD "MEDJIMURKA" D.D.  
Trg Republike 6  
40000 Čakovec  
HRVATSKA  
Tel.: +385 - 40 - 31 27 60  
Fax: +385 - 40 - 32 86 61

**HU**

Aspico Kft.  
Puskás Tivadar út.4.  
9027 Győr  
MAGYARORSZÁG  
Tel.: +36 - 96 - 51 12 91  
szerviz@aspico.hu

**IT**

Smart s.r.l.  
Via Tintoretto, 12  
21012, Cassano Magnago, (VA)  
ITALIA  
Assistenza Tecnica: 199 24 44 24  
Orari: 9:00 - 13:00h / 14:00 - 18:00h  
Fax: +39 0331 181 21 37  
info-dirtdevil@smartsrl.net

**NL**

Z.E.S. Goes B.V.  
T.a.v. afd. Service  
Pearyweg 1  
4462 GT Goes  
NEDERLAND  
Tel: +31 - 113 - 24 07 00  
Fax: +31 - 113 - 24 07 50  
dirtdevil@zesgoes.nl

**PL**

OBSŁUGA GWARANCYJNA I SERWISOWA  
QUADRA-NET Sp. z o.o.  
61-888 Poznań, ul. Składowa 5  
infolinia: 66 444 88 00

DYSTRYBUTOR I GWARANT  
DSV Sp. z o.o. S.K.A. Gdynia, Plac Kaszubski 8

**SI**

Strojinc Ciril s.p.  
Koseskega ul. 1a  
1000 Ljubljana  
SLOVENIJA  
Tel: +386 -1- 42 28 489

**SK**

Aspico Slovakia s r.o.  
Kracanska 40/104  
92901 Dunajská Streda  
SLOVAKIA  
Tel: +421 - 31 - 55 11 815

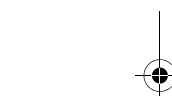





DE Garantie • GB Warranty • FR Garantie  
NL Garantie • ES Garantía • IT Garanzia  
TR Garanti

**NUR GÜLTIG MIT RECHNUNGSKOPIE! • VALID ONLY INCLUDING A COPY OF THE PURCHASE SLIP!  
VALABLE UNIQUEMENT AVEC UNE COPIE DE LA FACTURE! • ALLEEN GELDIG MET KOPIE VAN DE REKENING!  
¡VÁLIDO SÓLO CON COPIA DE FACTURA! • VALIDO SOLO SE CORREDATO DA UNA COPIA DELLA FATTURA!  
SADECE FATURA SURETİ İLE GEÇERLİDİR!**

Absender: Bitte Blockschrift in Großbuchstaben • From: Please print in capitals • Expéditeur : Veuillez écrire en caractères d'imprimerie et en majuscules •  
Afzender: a.u.b. blokletters in grote letters • Remitente: Por favor, escriba en letra de imprenta y en mayúsculas • Mittente: Per cortesia in stampatello a lettere  
maiuscole • Gönderen: Lütfen büyük harfler ve düz yazıyla

Name • Name • Nom • Naam • Nombres y apellidos • Nome • İsim

Straße und Hausnummer • Street and house number • Rue et numéro de maison • Straat en huisnummer • Calle y número • Via e numero civico • Sokak ve ev no

PLZ und Ort • Zip code and town • Numéro postal et lieu • Postcode en plaats • C.P. y ciudad • CAP e località • Posta kodu ve yer

Telefon mit Vorwahl • Phone number (with area code) • Téléphone avec indicatif • Telefoon met kengetal • Teléfono con prefijo •  
Telefono con prefisso • Şehirlerarası kodla telefon

**POPSTER**

E-Mail • email • Courriel • E-mail • Correo electrónico • e-mail • E-Posta

Kaufdatum • Date of purchase • Date d'achat • Datum van aankoop • Fecha de compra • Data d'acquisto • Satın alma tarihi

Datum, Unterschrift des Käufers • Date and owner's signature • Date, signature de l'acheteur • Datum, handtekening van de koper •  
Fecha, firma del comprador • Data, firma dell'acquirente • Tarih, satın alanın imzası

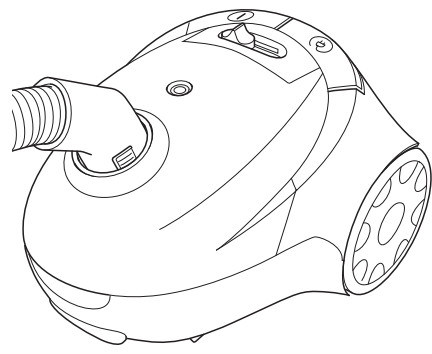

**Fehlerbeschreibung • Description of the malfunction • Description du problème • Omschrijving van de fout •  
Descripción del fallo • Descrizione del difetto • Hata tanımı:**

Bitte diesen Abschnitt ausschneiden und dem Gerät beilegen. • Please detach this part and send it in with the appliance. • Veuillez détacher cette partie et la joindre à l'appareil.  
Dit deel a.u.b. uitknippen en bij het apparaat leggen. • Por favor, recorte este resguardo y añádelo al aparato. • Per cortesia ritagliare questa sezione e allegarla all'apparecchio.  
Lütfen bu bölümü kesin ve cihazın yanına ekleyin.

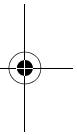
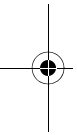

Royal Appliance International GmbH  
Jagenbergstraße 19  
41468 Neuss  
Germany

+49 (0) 2131 - 60 90 0  
+49 (0) 2131 - 60 90 60 95

info@dirdevil.de  
www.dirdevil.de

